

INCLUDING
*Communication
Engineering*
and
*TV & RADIO
ENGINEERING*

RADIO-ELECTRONIC *Engineering*

Reg. U.S. Pat. Off.

SEPTEMBER, 1954

MICROWAVE LINK FOR
WORLD-WIDE COMMUNICATION SYSTEM
7

RELIABLE TUBES
FOR AUTOMATIC PRODUCTION
10

COLOR ENCODING
12

TAPERED WAVE GUIDE ADAPTERS
15

VISUAL DEMODULATOR
FOR V.H.F.-U.H.F.
17

GLOBAL COMMUNICATIONS SYMPOSIUM
22

DEPARTMENTS

NEW PRODUCTS	24
COMMUNICATION REVIEW ..	26
NEW TUBES	28
NEW LITERATURE	30
CALENDAR	31
PERSONALS	32
TECHNICAL BOOKS	33
NEWS BRIEFS	34
TV-AM-FM PRODUCTION	36

A typical assembly of wide-band 900-mc. Type 72A radio equipment is shown undergoing tests at the San Carlos, Calif., plant of Lenkurt Electric Co., Inc. This equipment is for use in a multichannel system.



TELEVISION • ELECTRONICS • COMMUNICATIONS • AUDIO • MICROWAVES • RADAR • RESEARCH



Revolutionary LINEAR STANDARD AMPLIFIER

**NEW HEIGHT OF FIDELITY
20 WATTS
KIT FORM**



LINEAR STANDARD MLF AMPLIFIER



WITH COVER REMOVED

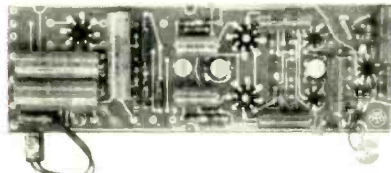

PRINTED CIRCUIT CONSTRUCTION



SUITED TO 7" RACK PANEL MOUNTING

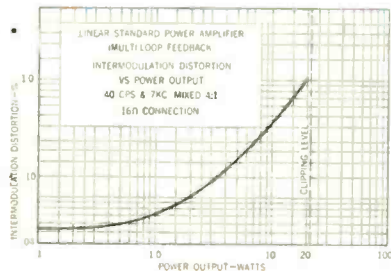

INTERMODULATION DISTORTION CURVE

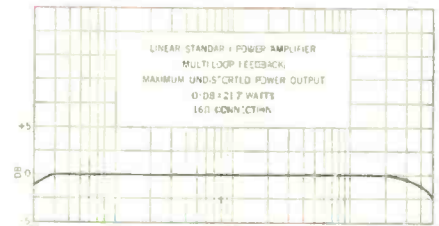

FREQUENCY RESPONSE CURVE

The Linear Standard amplifier climaxes a project assigned to our audio engineering group a year ago. The problem was, why does a Williamson circuit amplifier which tests beautifully in the laboratory seem to have considerable distortion in actual use? It took a year to fully determine the nature and cause of these distortions and the positive corrective measures. This new amplifier not only provides for full frequency response over the audio range but, in addition, sets a new standard for minimum transient distortion.

An inherent weakness of the Williamson circuit lies in the fact that its negative feedback becomes positive at subsonic frequencies. The resultant instability in use lends to parasitic oscillation at the high end and large subaudio cone excursions both of which produce substantial distortions. The Linear Standard Amplifier uses Multiple Loop Feedback and network stabilization to completely eliminate these instabilities. The oscillograms below show comparative performance. The flat frequency response and extremely low intermodulation distortion provided by 36 db feedback, are self evident from the curves shown.

In addition to providing an ideal amplifier electrically, considerable thought was given to its physical form. A number of points were considered extremely important: (1) Size should be minimum (power and audio on one chassis). (2) Each kit must have identical characteristics to lab model. (3) Rugged, reliable, structure is essential.

This resulted in a rather unique construction employing a printed circuit panel as large as the chassis with virtually all components pre-assembled and wired. The result is that each kit, which comes complete, including tubes and cover, can be fully pretested before shipment. Additional wiring involves only the connection of 17 leads to screw terminals for completion.

LINEAR STANDARD TYPE MLF AMPLIFIER SPECIFICATIONS...

Rated Power Output:	20 Watts
Intermodulation Distortion:	.07% -1W, 1%-20W
Frequency Response (controlled):	1 db 20 to 20,000 cycles
Hum & Noise Level:	80 db below rated output
Feedback:	36 db
Output impedances (not critical):	4, 8, 16 also 2, 5, 10, 20, 30 ohms
Tubes:	1-12X7, 2-6AU6, 2-5881, 1-5V4G
Dimensions & Weight:	5 1/4" x 8" x 1 7/8", 24 lbs.
Net Price:	\$108.00

COMPARATIVE PERFORMANCE

LINEAR STANDARD

WILLIAMSON TYPE

Step function
(low frequency)
transient stability.

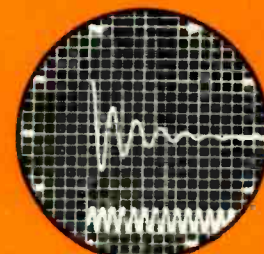
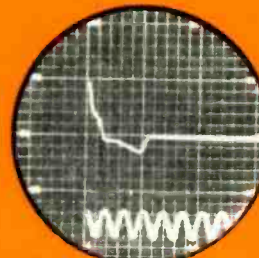

High frequency
oscillation stability.
Average speaker wiring
capacity.

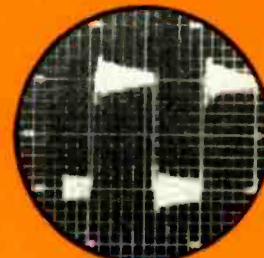
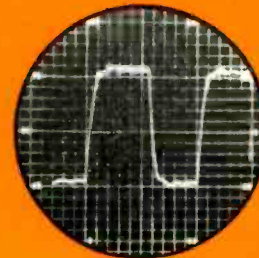

Overload recovery
transients.

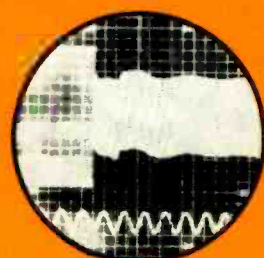
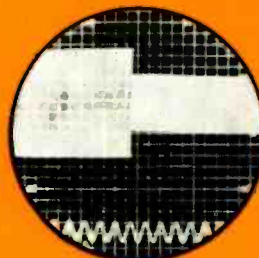

United Transformer Co.

150 VARICK STREET

NEW YORK 13, N. Y.

EXPORT DIVISION: 13 EAST 40th STREET, NEW YORK 16, N. Y. CABLES: "ARLAB"

RCA NEEDS ENGINEERS

who won't be held back!

RCA, world leader in electronics, has career opportunities for qualified **ELECTRICAL** and **MECHANICAL ENGINEERS** . . . **PHYSICISTS** . . . **METALLURGISTS** . . . **PHYSICAL CHEMISTS** . . . **CERAMISTS** . . . and **GLASS TECHNOLOGISTS** for long range work in military or commercial fields.

SYSTEMS—ANALYSIS—DEVELOPMENT
—DESIGN—APPLICATION ENGINEERING

in the following fields:

AVIATION ELECTRONICS (FIRE CONTROL, PRECISION NAVIGATION, COMMUNICATIONS)—Radar—Analog Computers—Digital Computers—Servo-Mechanisms—Shock & Vibration—Circuitry—Heat Transfer—Remote Controls—Sub-Miniaturization—Automatic Flight—Transistorization—Automation

RADAR—Circuitry—Antenna Design—Servo Systems—Information Display Systems—Gear Trains—Stable Elements—Intricate Mechanisms

COMPUTERS—Digital and Analog—Systems Planning—Storage Technique—Circuitry—Servo-Mechanisms—Assembly Design—High Speed Intricate Mechanisms

COMMUNICATIONS—Microwave—Aviation—Mobile—Specialized Military Systems

MISSILE GUIDANCE—Systems Planning and Design—Radar and Fire Control—Servo-Mechanisms—Vibration and Shock Problems—Telemetry

COMPONENT PARTS (COLOR & MONOCHROMETV)—HV Transformers—Coils—Deflection Yokes

SEMI-CONDUCTORS—Transistors—Diodes

ELECTRON TUBE DEVELOPMENT—Receiving—Transmitting—Cathode-Ray—Phototubes and Magnetrons—Power Tubes—Camera Tubes

ELECTRONIC EQUIPMENT FIELD ENGINEERS—Specialists for domestic and overseas assignment on military electronic Communications, Navigational Aids, and Guided Missiles.

At RCA you'll work in an atmosphere conducive to creative work—laboratory facilities unsurpassed in the electronics industry . . . constant association with leading scientists and engineers.

Positions now open in Systems, Analysis, Development, Design and Application Engineering. Your choice of long range work in commercial or military fields.

Delightful suburban living easily available. Modern retirement program . . . liberal tuition refund plan for advanced study at recognized universities . . . modern company paid benefits for you and your family.

Individual accomplishments readily recognized. Ample opportunities for increased income and professional advancement.

Join the team at RCA and grow with the world leader in electronics.

Personal interviews arranged in your city.

Please send complete resume of your education, experience, and specialized field preference to:

MR. JOHN R. WELD

Employment Manager

Dept. 3041

Radio Corporation of America

30 Rockefeller Plaza, New York 20, N.Y.



Tmks. ®

RADIO CORPORATION of AMERICA

its

CHICAGO Audio Transformers

for
Communications
High Fidelity
Public Address
Broadcast
Military
Industrial
and other
applications

CHICAGO audio transformers feature the famous "sealed-in-steel" construction. They have seamless drawn steel or cast cases for greater strength, moisture resistance and maximum shielding. These units are truly the world's toughest transformers.

These rugged transformers are designed to provide minimum leakage and hum pick-up, along with optimum coupling. Harmonic and intermodulation distortion are extremely low over the specified frequency ranges.



Most CHICAGO audio transformers are available in a choice of mounting styles, including hermetically sealed cases. You're almost sure to find the unit you require in the CHICAGO line of stock transformers.

FREE

Chicago Catalog CT-554 listing complete electrical and physical specifications on over 500 CHICAGO transformers. Available from your CHICAGO distributor or from Chicago Standard Transformer Corporation.

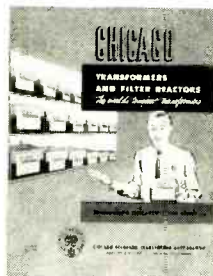

CHICAGO STANDARD TRANSFORMER CORP.

3501 ADDISON STREET • CHICAGO 18, ILLINOIS

EXPORT SALES:
Roburn Agencies, Inc.,
431 Greenwich St.,
New York 13, N. Y.

RADIO-ELECTRONIC *Engineering*

INCLUDING

TV & RADIO & *Communication*
ENGINEERING & **Engineering**

Edited by H. S. RENNE
and the Radio & Television News Staff

VOLUME 23 NUMBER 3
SEPTEMBER, 1954

Editor and Asst. Publisher
OLIVER READ, D. Sc., WIETI

Managing Editor
WM. A. STOCKLIN, B. S.

Technical Editor
H. S. RENNE, M. S.

Assistant Editor
M. C. MAGNA

Art Editor
FRANK SAYLES

Draftsmen
ALBERT A. GANS
JOSEPH A. GOLANEK

Advertising Manager
L. L. OSTEN

Midwest Adv. Manager
JOHN A. RONAN, JR.

Western Adv. Manager
JOHN E. PAYNE

ZIFF-DAVIS PUBLISHING COMPANY

WILLIAM B. ZIFF (1898-1953) FOUNDER
Editorial and Executive Offices
366 Madison Ave., New York 17, N. Y.

President
B. G. DAVIS

Vice-Presidents
H. J. MORGANROTH
M. H. FROELICH

Secretary-Treasurer
G. E. CARNEY

Circulation Manager
M. MICHAELSON

BRANCH OFFICES

CHICAGO (11): 64 E. Lake St.
LOS ANGELES (14): 900 Wilshire Blvd.

RADIO-ELECTRONIC ENGINEERING is published each month as a separate publication and is available by subscription only when purchased with a subscription to RADIO & TELEVISION NEWS.

(Average Paid Circulation Over 28,000)

Copyright 1954 by Ziff-Davis Publishing Company
(All Rights Reserved)



REPORTER MOBILE RADIO TELEPHONE

For Engineering Communications

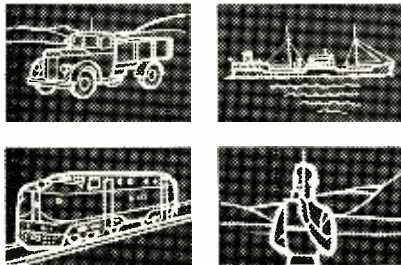

● The "Reporter", a compact and economical equipment designed to fit neatly under vehicle dashboards. Also available in transportable form or for use as a fixed station.

In civil engineering, control of mobile vehicles and personnel is all important. The Pye "Reporter", by providing an ever-present link to administrative H.Q., is of inestimable value in speeding up all remote operations and achieving vast economies in plant and manpower. Reason enough that it should feature so prominently in over two thirds of the V.H.F. schemes in the United Kingdom.



Telecommunications



Pye (New Zealand), Ltd.,
P.O. Box 2839,
Auckland C.1,
New Zealand.

Pye Canada, Ltd.,
Ajax,
Ontario,
Canada.

Pye-Electronic Pty. Ltd.,
65 Park Street,
Abbotsford, Melbourne,
Victoria, Australia.

Pye Ireland, Ltd.,
Manor Works,
Dundrum,
Dublin, Eire.

Pye Radio & Television (Pty.) Ltd.,
P.O. Box 10648,
Johannesburg,
South Africa.

PYE LIMITED • • CAMBRIDGE • • ENGLAND

E.4

New circuit development obsoletes conventional UHF 2-Way Radio design



IMMEDIATE DELIVERY!

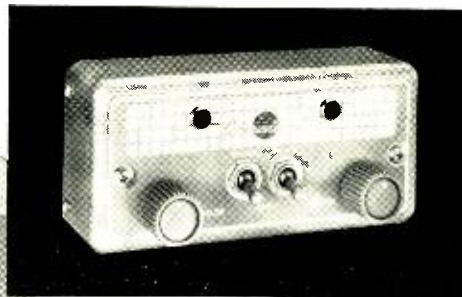

Connecticut **FLEETWAY** FIRST FM 2-WAY RADIO

UNIQUE CONN-TENNA DESIGN BEAMS STRONG HORIZONTAL SIGNAL

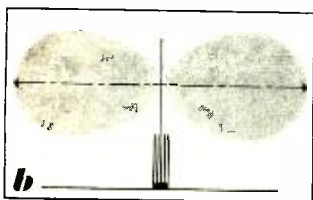
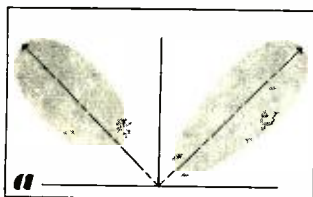

More evidence of FLEETWAY's radical design is found in its new Conn-tenna. Sketch A shows how conventional monopole antenna dissipates much of its signal at 45° upward angle. Sketch B shows how multipole Conn-tenna concentrates radiation along a horizontal plane, transmitting a stronger signal with lower power requirement.

HIGHER OVERTONE • The patented Lister circuit uses a starting frequency of 75 Mc instead of the usual 6 Mc. Low 6-time frequency multiplication required to reach 450 Mc contrasts with 24-times or more in other types of equipment.

GREATER STABILITY • Direct circuitry and fewer components permit better control of signal output, greatly minimize drift and spurious radiation. Result is greater stability requiring minimum maintenance, producing clearest signal ever attained in mobile radio.

'FM' CLARITY MINUS NOISE • True frequency modulation — for the first time in mobile radio — produces noise-free, natural tone quality, and eliminates distortion so common in conventional equipment. *This is true FM, not commonly used phase modulation (PM).*

LOWER OPERATING COST • Simplified FLEETWAY circuitry requires fewer tubes and parts — uses standard, lower cost crystals and tubes, needs less servicing.

NEW 450-470 Mc BAND OPENS 2-WAY RADIO TO EVERY CITIZEN AND COMPANY

• Even if you have not been able to obtain a license for 2-way radio for yourself or your business, the chances are you can now get an immediate assignment in the recently opened 450-460 commercial fleet band or in the 460-470 citizens' band. These new bands offer easy licensing requirements for anyone who does not qualify in one of the older channels. You can now enjoy the advantages of FLEETWAY mobile radio for business or private use.

See your local FLEETWAY dealer or write for "Technical Comparison" booklet containing parts and performance comparison of leading mobile radio equipment.

Connecticut

CONNECTICUT TELEPHONE & ELECTRIC CORP.

102 BRITANNIA ST.

MERIDEN, CONN.

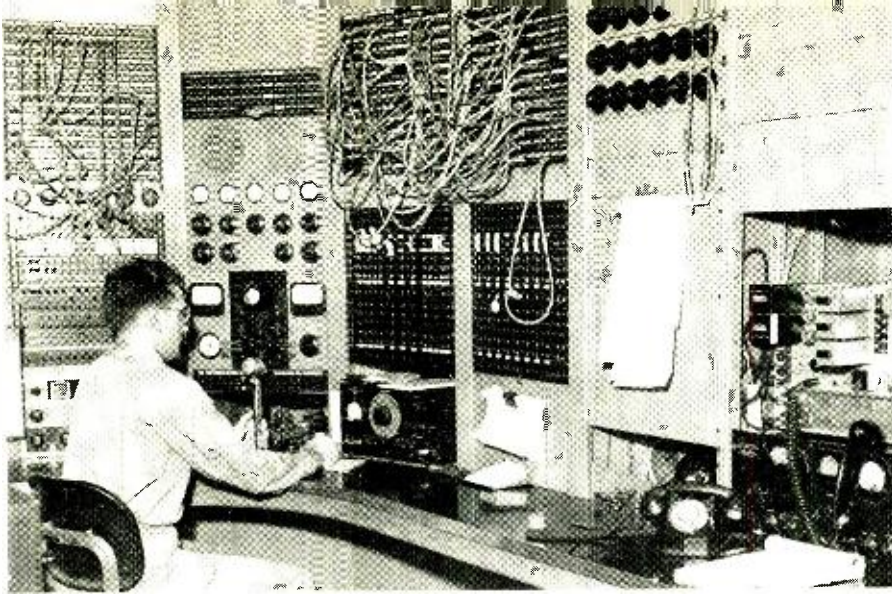

Control room at Rocky Point; terminal service unit (right) warns of system faults.

Microwave tower, antennas and equipment building at the Dix Hills relay station. This station is unattended.

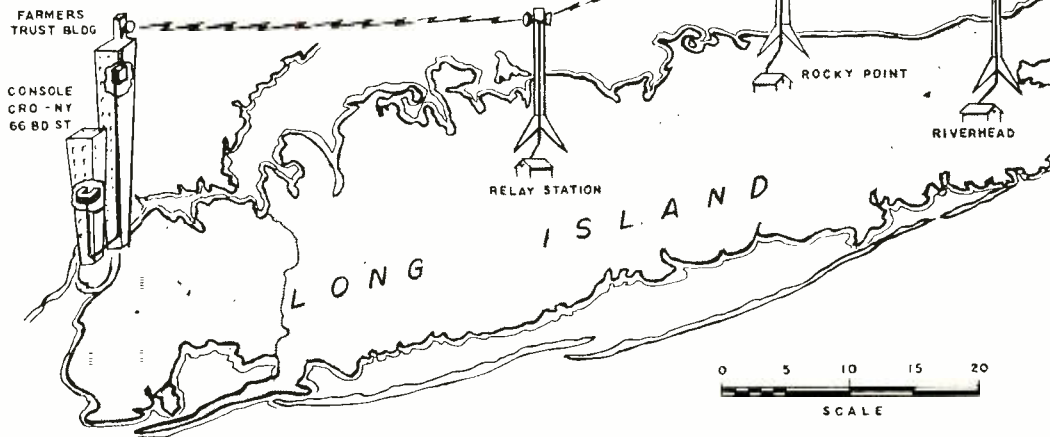
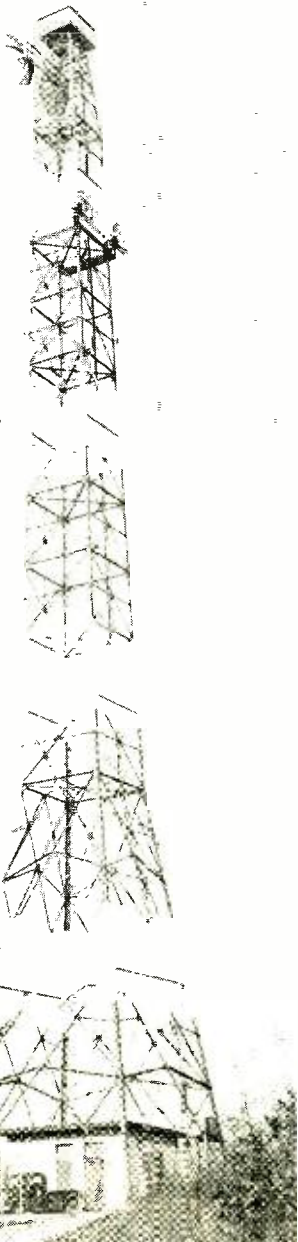

Map showing general location of various elements of the RCA microwave relay system.

MICROWAVE LINK

FOR WORLD-WIDE COMMUNICATION SYSTEM

WHEN *RCA Communication's* new microwave radio relay link begins operation late in 1954, it will connect the central radio office in New York City with powerful transatlantic transmitters at Rocky Point, Long Island, 61 miles away, and with overseas receiving antennas at Riverhead, Long Island, 75 miles away. This microwave link, now being tested, will insure rapid and reliable transmission of radiograms, radiophotos, teleprinter services, and commercial radio programs to and from many parts of the world. The system will operate into automatic printers, perforators, reperforators, and "package set" transmitters at the central radio office, into automatic keyers at Rocky Point, and into the patching center at Riverhead. It will be completely owned, operated and controlled by the company and will eventually take the place of leased wire lines.

Twin-beam dual-multiplex system will replace wire link from central office to the overseas circuits.

By

C. H. BACKUS

RCA Communications, Inc.

and

S. LAPENSON

Engineering Products Div., RCA

The *RCA* microwave system includes three microwave terminal stations: one at New York City, another at Rocky Point, and a third at Riverhead. At Dix Hills, Long Island, an unattended repeater station relays signals in both directions between New York City and Rocky Point.

Features of System

In order to meet the rigid reliability requirements of a commercial carrier, a number of important design features are included to insure uninterrupted, continuous service. One innovation is the use of two parallel microwave beams to link all stations. In effect, one of the parallel beams provides a "fall-back," or alternate route, similar to those which are commonly used in commercial communications. Inserted channels pass a dividing network and are propagated simultaneously on each of two beams. At receiving points,

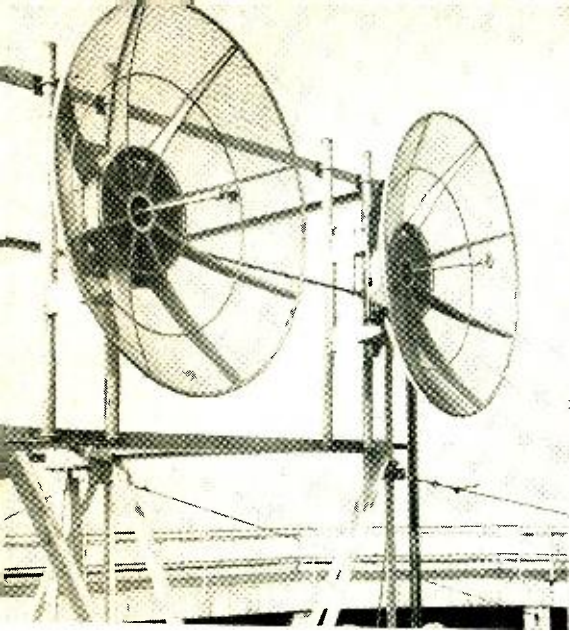

Microwave antennas on roof of City Bank and Farmers Trust building in New York City are beamed directly at Dix Hills.

automatic switching equipment—controlled by three pilot tones associated with the multiplex gear—shifts all channels from one microwave chain to the other as required. Delay circuits prevent unnecessary switching or “hunting” between chains. In addition, an operator can select the beam which will best suit operating conditions and can clear any one beam for test purposes.

Standard multiplex techniques are used to provide the large number of channels required. One set of CW-20 microwave equipment, associated with one beam, operates in conjunction with single-sideband frequency-division multiplex gear, while a duplicate set of CW-20 microwave equipment, associated with the other beam, operates with pulse-amplitude multiplex gear. The CW-20 microwave equipment has shown that it works to perfection with either the frequency-division or the pulse-amplitude technique.

The microwave system provides 19 narrow-band channels (300-3000 cps), and three broadband channels (100-5000 cps), in order to accommodate a variety of communication services. Total bandwidth of the system is 300 cps to 135 kc. RCA radiophoto is a typical service used by business concerns to transmit legal documents, diagrams, and financial statements to branch offices and customers overseas. In addition, TEX (teleprinter exchange service) transmits thousands of words of press copy daily for newspapers and news agencies. TEX also provides direct connections between business concerns on both sides of the Atlantic.

RCA transmits commercial radio programs overseas, and receives programs from overseas for broadcast in the United States. For this service, the microwave system provides the three broadcast channels which are rated at class A, or better. The 19 narrow-band channels can handle 304 radiograms in both directions at one time. At an average speed of 60 wpm, these facilities can thus handle 36,480 words in a single minute.

Microwave Stations

New York City

The New York City terminal station is located in the tower of the City Bank and Farmers Trust Company building. Control lines connect the microwave station to the company's busy central radio office, a short distance away, which is the control point for both outgoing and incoming communications.

At the central radio office, communications for overseas points are routed to operators who work specific circuits to key cities around the world. Radiograms, which are in the form of five-unit perforated tapes, are fed into “package sets” which receive as well as transmit. Those communications which are bound for Hawaii, Australia and the Far East are relayed to the company's West Coast office at San Francisco to be beamed by radio across the Pacific. Those communications which are bound for countries across the Atlantic are fed into the microwave system and sped to Rocky Point where powerful short-wave transmitters beam them overseas; at the same time, signals which are picked up at the Riverhead overseas receiving station are carried back to New York City.

Traffic on the microwave system is controlled by the dispatcher at the central radio office; he issues instructions to the operators at Rocky Point and Riverhead by means of teletype printer equipment which operates on one of the channels of the microwave system.

Layouts for the various stations are more or less conventional. In New York City, all station equipment is contained in 11 cabinets which are housed in a wire cage two floors below the roof. One complete CW-20, 2000-mc., T1 microwave terminal station assembly—contained in a single cabinet—operates in conjunction with three cabinets of narrow-band frequency-division multiplex equipment and one cabinet of wide-band frequency-division multiplex equipment. A second CW-20, 2000-mc., T1 terminal station operates in con-

junction with three cabinets of pulse-amplitude multiplex equipment. Two racks are provided for telephone and miscellaneous station equipment.

On the roof, two antennas mounted on a raised platform are beamed directly across the tip of Manhattan at an approximate height of 710' above sea level. One antenna serves one of the microwave beams, and the second antenna, the other. Special duplex filters enable each antenna to transmit and receive simultaneously. These filters consist of resonant cavities which are tuned to the particular transmitting and receiving signals at each station. The transmitter filter is sufficiently selective to accept only the transmitted frequencies while preventing the incoming signal from entering the transmitter output circuit; the receiver filter prevents the transmitter signal from entering the receiver. A $\frac{7}{8}$ " coaxial line with a grounded outer conductor passes through the roof of the building to connect the microwave equipment to the antennas, which have a clear line of sight to the Dix Hills repeater station.

Dix Hills

The unattended relay station at Dix Hills is built on an elevated plot of ground off Route 25 which runs the length of Long Island. Near the top of a 210' tower, two adjacent 10' parabolas are pointed directly toward the New York City microwave station. On the other side of the tower, and somewhat lower, two adjacent 6' dishes are aimed at Rocky Point. A concrete blockhouse at the base of the tower provides safe housing for the microwave equipment.

Beamwidth of the 6' antennas at 3-db points is 5.3 to 5.8° in the *E* plane, and 4.9 to 5.5° in the *H* plane. The specific value depends on the exact frequency being used. Radiated power at each microwave transmitter is about 3 watts.

Numerous design features insure highly reliable unattended operation. The temperature inside the building is kept constant by thermostatic controls, and automatic fault indication facilities—which are normally an integral part of CW-20 microwave systems—keep a constant check on the performance of the unattended station.

These automatic facilities report such irregularities as the failure of a top tower light beacon or any of the side tower lights, excessive temperatures in the operating or power generator rooms of the blockhouse, and an illegal sta-

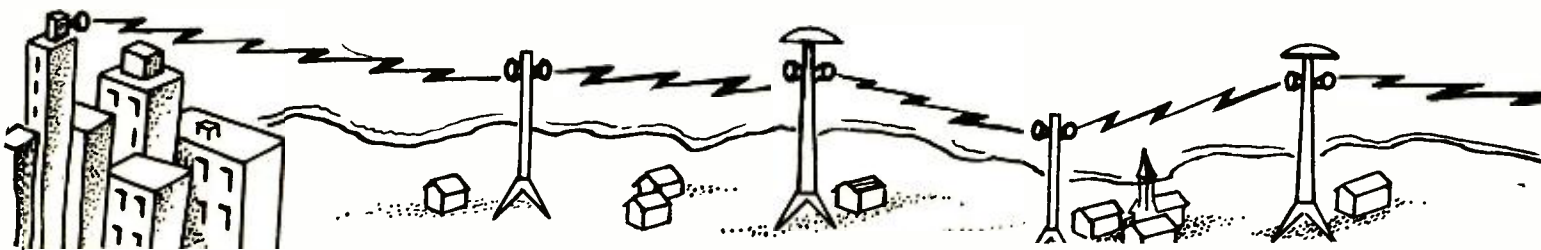

tion entry. Also provided are two automatic carrier indications and a motor generator indication. If an irregularity should occur, a specially devised CW-20 repeater service unit will transmit coded signals to a terminal service unit located at Rocky Point. Flashing neon bulb indicators will display the specific irregularity at each station for prompt servicing.

As an additional aid to maintenance, a private service channel which connects all stations enables each station to correspond by handset with any other on a party line basis. Even if a fire should occur in the emergency power room, a sensitive pneumatic-control head, which responds to a rise in temperature greater than 15° per minute, will automatically flood the room with CO₂ gas. At the same time, automatic controls will cut off the generator to prevent further damage to the power equipment and send an alarm signal to Rocky Point.

Rocky Point

On a sandy 10-square-mile track at Rocky Point, on the north side of the island 61 miles from the New York mainland, a microwave terminal station makes available to the overseas transmitters the incoming messages beamed from New York. This station also relays back to the home office communications which are received from Riverhead.

The Rocky Point microwave terminal station is housed in a concrete blockhouse near Building 1, the main transmitting station. Microwave antennas are mounted on one of the tall towers

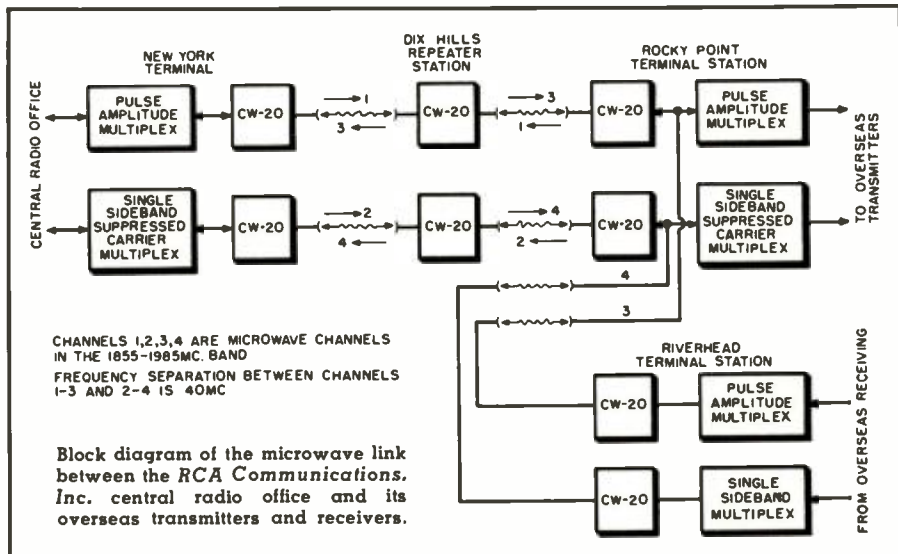

which carry signals to the overseas points. The antennas are about half-way up the towers at a height of 165 feet. Two antennas, 6' in diameter, are directed to the antennas at Dix Hills, while two 4'-diameter antennas are directed to Riverhead. The 4' antennas have a beamwidth at 3-db points of 9.3 to 9.7° in the *E* plane and 8.2 to 8.9° in the *H* plane.

Overseas radiograms and other communications which the microwave system relays into Rocky Point are converted and patched directly to specific overseas transmitters in accordance with directions from the dispatcher in New York. In this manner, Rocky Point acts as an automatic relay point for communications which are headed overseas.

Riverhead

At Riverhead, incoming messages from countries around the world are picked up by arrays of sensitive antennas and applied to the microwave system for transmission back to the central radio office in New York City. Diversity reception combines the signals from three separate antennas to produce a signal of optimum clarity before it is applied to the microwave system. This station acts as an automatic relay point for overseas messages on their way to New York City.

The station equipment and the concrete blockhouse at Riverhead are similar to those at Rocky Point. Two parabolic antennas, mounted about 125 feet

(Continued on page 31)

Dehydrator units in back of microwave equipment at Dix Hills. Cables have still to be dressed, tags removed from equipment, and doors added to cabinets.

RCA Type CW-20 microwave radio relay equipment at Rocky Point terminal station. The duplex filters can be seen immediately above the racks.

Joe Lubina, an RCA Communications technician, is shown adjusting signal levels on the multiplexing gear at the New York City terminal station.

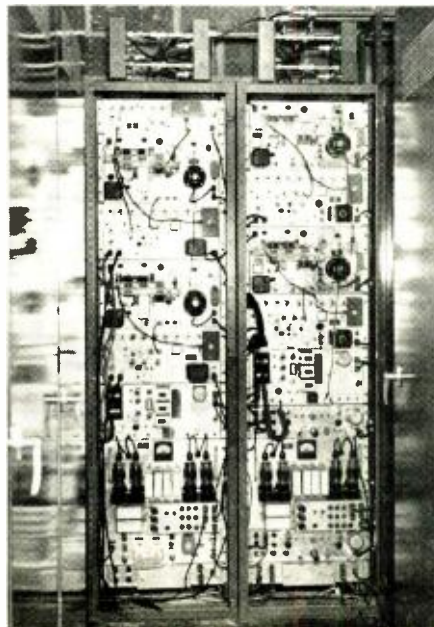
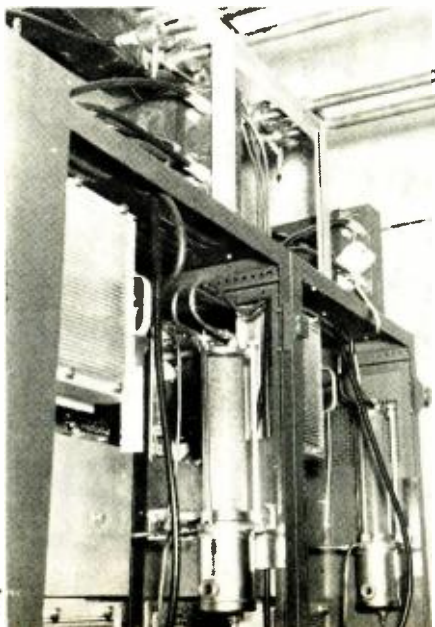

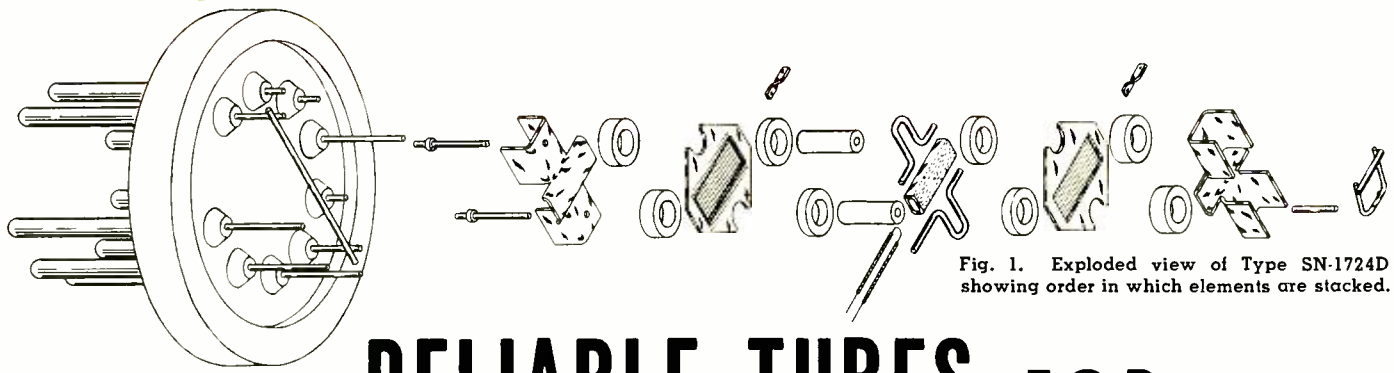

Fig. 1. Exploded view of Type SN-1724D showing order in which elements are stacked.

RELIABLE TUBES FOR AUTOMATIC PRODUCTION

By **W. R. WHEELER** and **T. L. EVANS**

Sylvania Electric Products Inc.

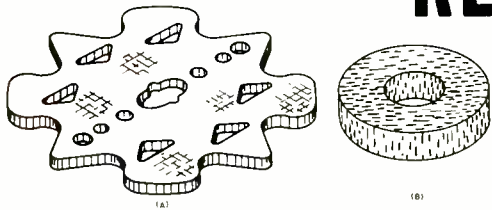
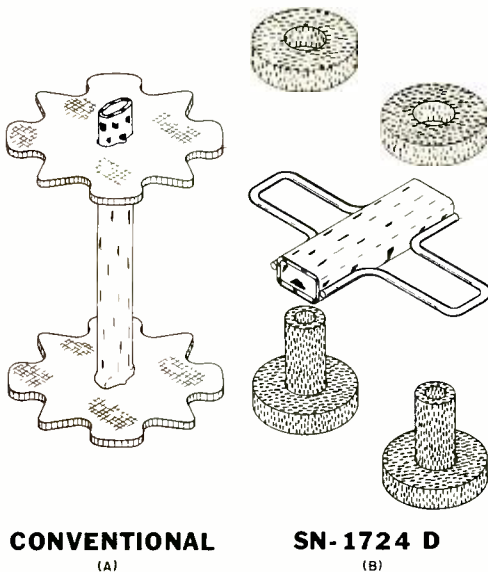

Fig. 2. (A) Mica and (B) ceramic spacers.



CONVENTIONAL (A) SN-1724 D (B)

Fig. 3. (A) Conventional cathode and (B) loop cathode support of a "stacked tube."

Fig. 4. (A) Side-rod and (B) frame grids.

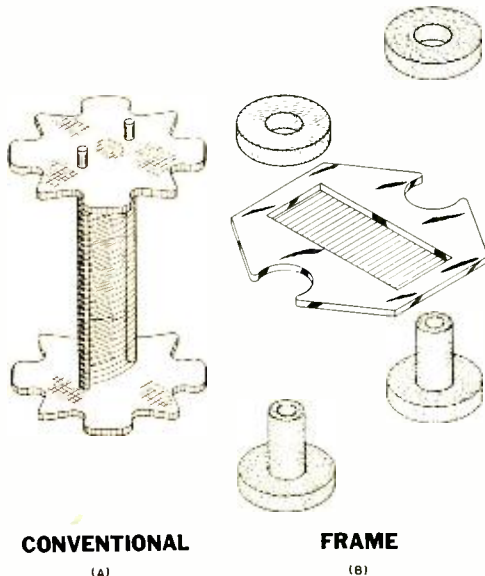

CONVENTIONAL (A) FRAME (B)

MILITARY requirements for reliable electronic components have become increasingly severe in the past decade because of the growing complexity of the equipment involved and the more and more stringent environmental conditions imposed. Great strides have been made during this time by the component manufacturers in quality control of their products, and marked improvement has been made in performance under adverse mechanical and thermal conditions.

In the receiving tube field, the "premium" lines of subminiatures, the "Five-Star" line of miniatures, and the "W" category of larger sizes offer a much higher order of reliability under military operating conditions than their pre-World War II prototypes. A reduction in failure rate of roughly 50 to 100 times has been achieved.

It recently became apparent that although further refinement of tube designs and manufacturing techniques would be possible, another large order of improvement could best be achieved by adopting new techniques of tube construction. Also, in the event of all-out military effort, unprecedented quantities of highly reliable receiving tubes would be required. Thus, it appeared that an entirely new approach to tube design was needed—one that would not only overcome the disadvantage arising from the use of conventional receiving tube materials but would also facilitate construction by automatic assembly. Automatic assembly would not only yield a saving of skilled manpower but would inherently improve reliability in two categories: uniformity of characteristics, and freedom from failure due to operator error.

Design Project

As a result of the above-mentioned considerations, a project was under-

taken under the auspices of the Navy Bureau of Ships (Contract NObsr 52627), with the objective of designing tubes amenable to machine assembly. Another objective, of course, was to improve on the reliability of conventional prototypes. Effort was made to achieve automation of assembly and improved reliability without sacrifice of electrical efficacy or convenience of size and form. Tube constructions investigated were all designed to avoid the assembly operations of conventional structures that are so difficult to mechanize, such as the simultaneous feeding of many cylindrical parts through close-fitting holes in a mica spacer where the control of characteristics depends on the tightness of fit and the location of the holes as well as the dimensions of the parts. The construction to be described involves assembly by a simple piling or stacking of parts and a final clamping of the stack; hence, the term "stacked tube" is applied to such construction.

Improvements Achieved

One of the several designs developed under this program is the SN-1724D. Tests indicate a great improvement in uniformity of characteristics, ruggedness and stability of characteristics.

An exploded view of the SN-1724D is shown in Fig. 1. The mount is assembled, beginning with a plate through which two rivets fit. Ceramic insulators are dropped over the rivets and parts are successively dropped over the insulators—first the grid-plate spacers, then a frame grid, grid-cathode spacers, cathode assembly, and so on until the plate of the second section is dropped over the rivets. The mount is compressed and the rivets swaged over to bind the stack. There is no mica in the mount and completed assemblies are sealed in a new ceramic-type enve-

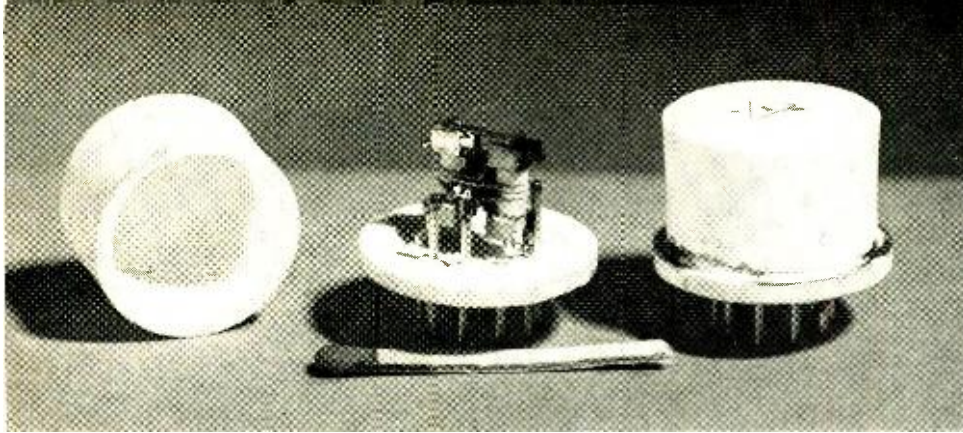

Fig. 5. Ceramic envelope (left), subassembly (center) and complete stacked tube (right).

Radically new "stacked tube" construction increases reliability and makes automatic assembly possible.

lope. How particular design features of the SN-1724D differ from their conventional prototypes is indicated in detail in Figs. 2, 3 and 4.

Figure 2 contrasts a mica spacer with a ceramic spacer. Ceramic spacers are stronger, more rugged than mica, and simplify machine handling in automatic mounting. Spacing between elements of a conventional tube depends on the accuracy of parts and the accuracy of mica holes. The holes in the mica, which further weaken the part, are punched with an accuracy of .0005" at best, and allowable variations between hole centers add another .0005" to spacing tolerances. The only critical dimension of ceramic spacers is the thickness dimension, which is controlled by grinding to an accuracy of .0005"; since the ceramic is a rigid body, it is readily adaptable to automatic gauging.

Chemical instability of mica has long been a problem for radio tube manufacturers. In particular, the mica contacting the anode and cathode becomes heated and releases water of hydration. Frequently, under conditions of shock and vibration, small flakes of mica separate and eventually contact a hot surface. The water of hydration which is released is detrimental to tube life. In contrast to ceramic bodies, the composition of mica is not controlled but must be used as mined. The finest mica available is mined in India and unfortunately becomes a strategic material in times of emergency. Also, mica is a material that is subject to fatigue under shock and vibration as ceramic is not. The effect of mica fatigue can be seen in the enlargement of holes with a resulting rise in noise output. When the stacked mount is compressed and

Fig. 7. (A) Life test graph comparing SN-1724D stacked mount in glass envelope with conventional Type 5718 at room and high ambient temperatures. (B) Life test results showing superiority of ceramic over glass at high ambient temperatures.

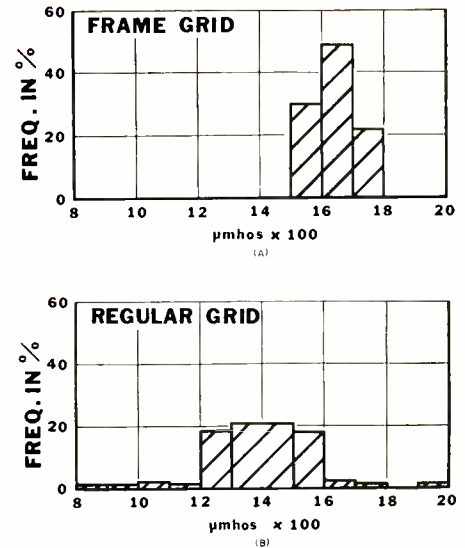
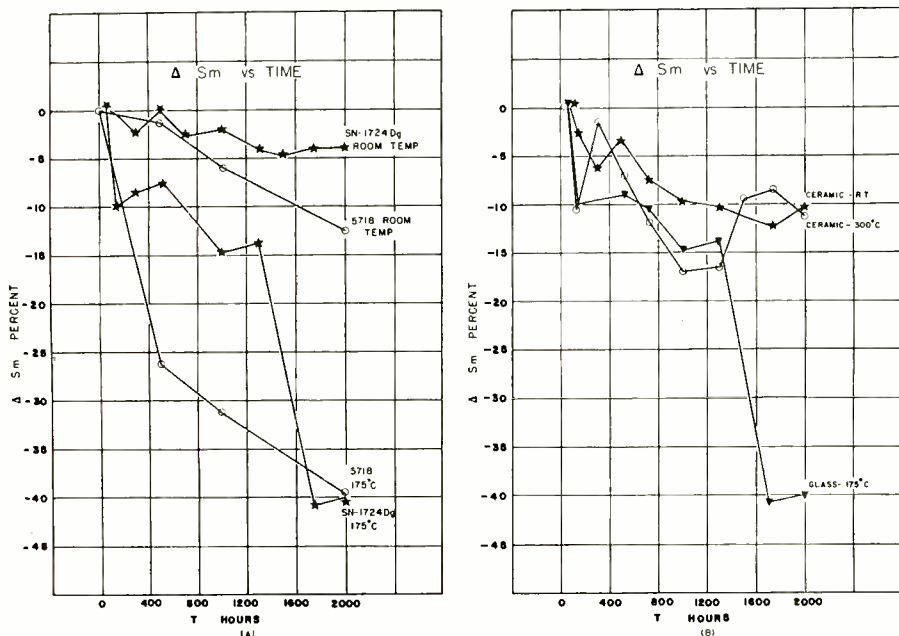

Fig. 6. Transconductance charts for (A) frame grid and (B) regular grid showing improved uniformity provided by frame grid.

swaged, the parts are securely locked in place; and since ceramic spacers are not subject to fatigue, noise output is not increased after high-level shock and long-time vibration.

Figure 3 compares the loop cathode support with a conventional type of cathode support. Each end of a conventional cathode is inserted through a mica spacer. Location and stability of location of this cathode are limited by the fit and wear of the spacers. The cathode sleeve is too delicate to press into the hole; therefore, clearance must be allowed. Clearance is also necessary to accommodate expansion of the sleeve when heated. On the other hand, the loop-supported cathode can be rigidly clamped in the stack. The entire emission surface of the loop cathode can be used, in contrast to the wasted surface on conventional types needed to allow for mica support and jammed turns. The loop material is made of 42 nickel iron alloy for thermal isolation and is located accurately to maintain precision in grid-cathode spacing.

Further quality improvements are gained by the use of frame grids in place of side-rod types. Both are shown in Fig. 4. The frame grid is wound with tungsten laterals that are brazed to a molybdenum frame with residual tension left in the wires. Construction of the frame grid is obviously more rugged than that of the side-rod type, and is much less susceptible to handling damage. The side-rod grid is limited in turns per inch and smallness of wire size which can be wound because of the nicking and swaging technique. As there are no such limitations on frame grid winding, higher performance tubes can be made.

Most important of all, perhaps, is the superior dimensional control held
(Continued on page 36)

COLOR ENCODING

By

R. F. CASEY and R. W. DEICHERT

Circuit Research Labs., Allen B. Du Mont Laboratories, Inc.

Principles of processing color information and combining it into a signal which occupies a standard 6-mc. channel.

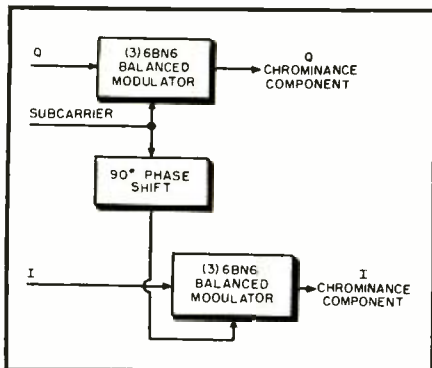

Fig. 1. Block diagram of the balanced modulators used in the new Du Mont Type 9016 color encoder.

Fig. 2. Element configuration of the type 6BN6 "gated beam" tube. Three are used in each modulator.

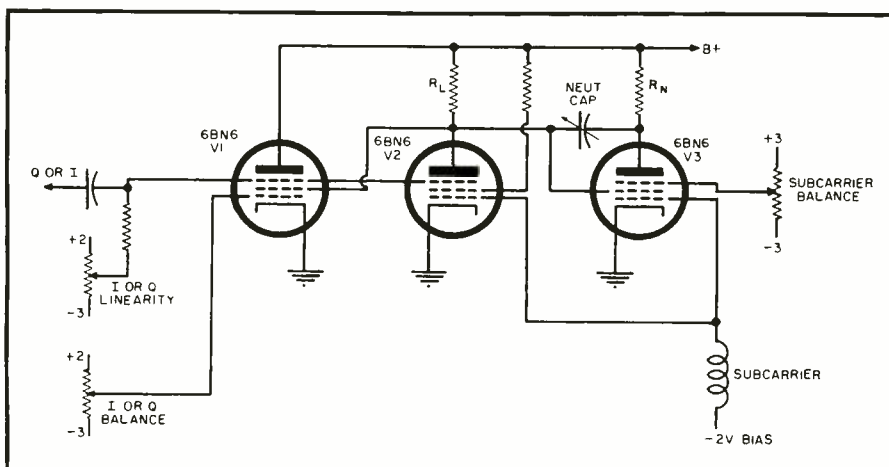
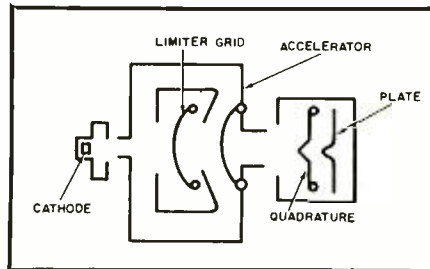
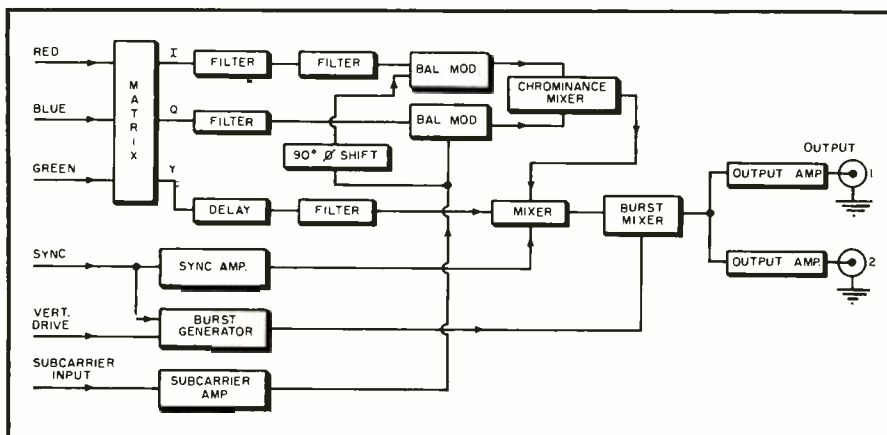

Fig. 3. Schematic diagram of a balanced modulator unit. Identical circuits are used for both the I and Q units.

Fig. 4. Block diagram of the complete Type 9016 color encoder. The balanced modulators follow the I and Q filters.



ONE of the principal steps in the transmission of color television signals is that of packaging simultaneous color information into a signal which will operate both monochrome and color receivers. This packaging process is called encoding. The recently FCC-approved system of compatible color television now requires that the broadcaster, when originating programs, perform the encoding process which heretofore has been done with laboratory-type equipment. Therefore, the broadcaster needs a device capable of performing the task with the proper degree of precision for long trouble-free periods. The dual purpose of this paper is to set forth the principles of encoding briefly and to describe the reduction of these principles to a commercially available encoder.

Encoding Function

The function of the encoder in color television consists of processing the essential information as received from the color pickup devices and combining

Fig. 5. Front view of color encoder.

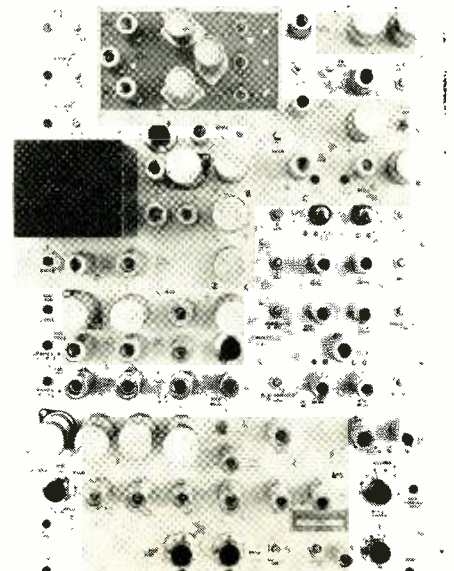

it into a signal occupying a standard 6-mc. channel. This signal, as specified by the FCC, carries all the essential information in a form that can be dissociated at the receiving end. In monochrome television, luminance or brightness is, of course, all the video information that is required. For a rendition in color, the specified three primaries can reproduce most of the colors existing in nature. Since a mathematical relationship exists between the amounts of these three primaries, it follows that they may be manipulated in any manner in preparation for transmission so long as the converse manipulation is performed at the receiving end to recover the original signals. If brightness is chosen as one of the signals to be broadcast, consisting of fixed percentages of red, green, and blue, two mathematical quantities remain. These are termed *I* and *Q* and also contain fixed values of red, green, and blue. When modified for transmission on the subcarrier at 3.579545 mc., the *I* and *Q* subcarrier vectors define the hue and saturation. Since the monochrome receivers are satisfied with luminance and ignore *I* and *Q*, the happy condition of compatibility now exists. Color receivers are equipped to translate the transmitted information into luminance, hue, and saturation.

In confining this information to a single channel, all opportunities for band-saving were exploited. Advantage was taken of the fact that the carrier may be modulated by two bands of information (carrier-suppressed). The phase of the carrier is shifted 90° for the second band. (The carrier referred to here is the subcarrier at 3.579545 mc.) Further advantage is taken of the fact that the energy content of the television signal is grouped in narrow bands about harmonics of the horizontal line frequency. Since the subcarrier frequency is an odd multiple of one-half the line frequency, it is also an odd multiple of the frame frequency. Over two complete fields, the chrominance information that extends into the luminance portion of the band tends to cancel subjectively.

Modulation Process

The modulation process by which the chrominance information is translated into sidebands of the subcarrier frequency is the heart of the encoder and must fulfill the following requirements:

1. To have color fidelity, the balance of the subcarrier must be maintained over long periods of time, and linearity of output vs. input must be good.
2. For freedom from spurious emissions, the *I* and *Q* signals must be balanced for the harmonic as well as fundamental frequencies.

3. For ease of maintenance, adjustments should be few and not inter-related, and should not require continual resetting.

A conventional modulation process utilizes two 6AS6 tubes sharing a common plate load resistor. The carrier is injected into the first grid of one of these tubes, and the same carrier rotated 180° is injected into the corresponding grid of the other tube. Since the space currents of these tubes are out of phase, the voltage produced at the common plate is zero. If the *I* or *Q* signal is injected into the suppressor grid of one tube and this same signal inverted 180° is injected into the other tube, again there is cancellation and no manifestation of this signal appears at the common plate. With the application of subcarrier and *I* or *Q*, the sideband information appears at the common plate. For such a system to be suitable, it must be capable of sustaining balance of both the subcarrier and the *I* and *Q* signals for an indefinite period. In the system just outlined, long-term stability leaves much to be desired inasmuch as the G_m tends to be a function of heater temperature and d.c. potential of the electrodes. Secondly, since both the subcarrier and the *I* and *Q* signals must be inverted, there are additional uncertainties and instabilities in the inverting tubes.

Balanced modulators developed by Allen B. Du Mont Laboratories eliminate instability due to inversion tubes and, further, have the advantage of inherent stability. The tubes incorporated in the modulators are the well-known gated beam tubes (type 6BN6). It may be enlightening to discuss the construction and general characteristics of the 6BN6 (see Fig. 2).

1. Cathode current is dependent only on the accelerator voltage. The limiter grid, the quadrature grid, and the plate voltages determine to which tube element the current will flow, but have little effect on the total cathode current.
2. Both the limiter grid and the quadrature grid have positive transconductance to the plate and negative transconductance to the accelerator. For each grid, the positive transconductance equals the negative transconductance for all values of grid voltage. These facts follow naturally from the fact that the cathode current is independent of the voltages of these grids.
3. The limiter grid (first grid) is located much farther away from the cathode than the conventional space-charge tube and is contained in a cavity through which the electron beam has constant velocity, thus making it more immune to mechanical deformations such as that

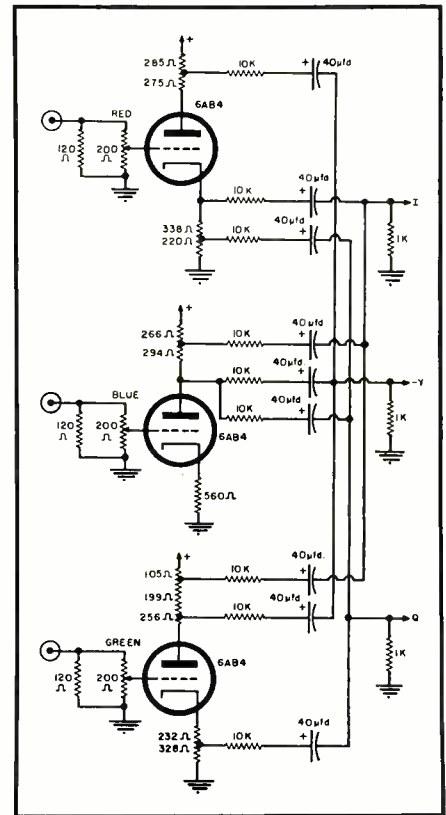
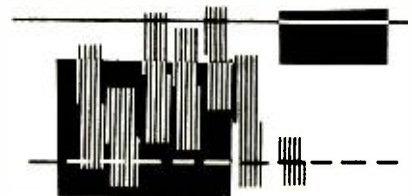
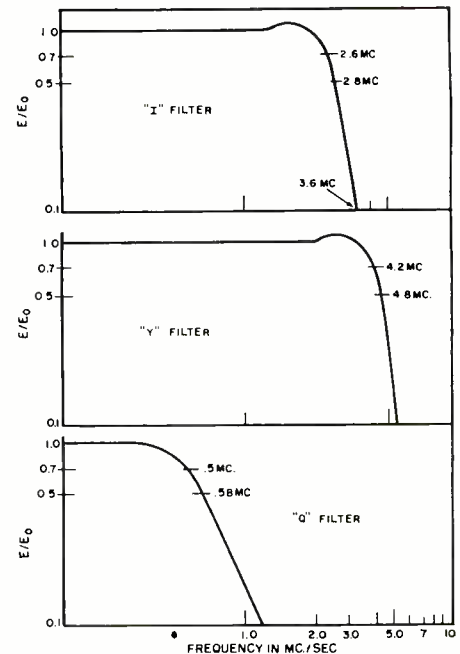

Fig. 6. Schematic diagram of the color matrix appearing in Fig. 4.

Fig. 7. Responses of the *I*, *Y* and *Q* filters which follow the matrix.



caused by heater temperature changes.

4. Neither grid draws current for negative voltages. The current increases to a few hundred microamperes at a few volts positive, and drops to only a few microamperes as the voltage is further increased positively. This allows the tubes to be operated with the grids positive without damage to the tubes. Over a long period of time, the only damaged tubes that were encountered were one with an open heater and one in which a very high voltage was accidentally applied to the limiter grid.
5. Both grids have an optimum point on their grid voltage transconductance curves and a fairly large grid swing with constant transconductance.
6. The tubes are very stable, but tube nonuniformity makes circuit adjustment necessary when tubes are changed.

Referring to Fig. 3, the following is a brief description of the balanced modulator operation.

Without an I or Q signal and without a subcarrier signal, the cathode currents in the three tubes are about equal. Some current flows to the accelerators and the remainder to the plates. If subcarrier voltage is now applied starting from zero and going negative, the space current in tubes V_2 and V_3 previously flowing through the accelerator to the plates is now increasingly diverted to the accelerator. The plate voltage of V_2 tends to rise because of the deletion of V_2 plate current through the common load. At the same time, however, the accelerator current of V_3 is increasing, which tends to reduce the voltage at the plate of V_2 , canceling the signal completely. The quadrature grids behave in the same manner as the limiter grids inasmuch as they determine whether the current emerging from the accelerator shall continue on to the plate or be turned back to the accelerator.

The description so far covers the fundamental balance. A closer inspection will show that since the sum of the negative G_m plus the positive G_m of each grid is zero, zero distortion will result. Because capacitance exists between the limiter grid and the accelerator of V_3 , which is the output terminal, the subcarrier is fed directly through to the output. This subcarrier may be canceled by adding a small resistor in the plate of V_3 and by means of a small variable capacitor coupling this out-of-phase signal to the output. To complete the system, it is, of course, necessary to have two balanced modulators with a subcarrier shifted 90° , the one producing the I component of chrominance, the other the Q component of chrominance. These two signals are then mixed in a mixer tube.

Design of Encoder

Many circuit configurations and avenues of approach are possible in designing a piece of equipment to perform the functions just described. The Circuit Research Laboratories of the *Allen B. Du Mont Laboratories*, when faced with the problem of designing the Type 9016 color encoder, set the following design objectives: (1) that the end result should be a piece of equipment capable of being operated by TV station personnel with a minimum of effort, i.e., it should be easily adjustable and have a maximum amount of operating reserve and stability; and (2) that single chassis construction should be utilized and all latest circuit techniques incorporated. How these objectives were attained can be judged from the description of the unit shown in Fig. 5. A functional block diagram is shown in Fig. 4. The description can logically proceed by tracing the path of the simultaneous color signal inputs through the unit to where they emerge as a composite signal capable of modulating the transmitter.

A simplified resistive matrix is used to derive the Q , I , and Y signals from

the simultaneous red, blue, and green signals fed to the unit by 75Ω coax at .75-volt peak-to-peak level. (See Fig. 6). The proper polarity and amplitude of the signal components comprising I , Q , and Y are determined respectively by the point in the tube circuit used (i.e., cathode or plate) and by $\pm 1\%$ tolerance selection of the resistors used to make up the equal plate and cathode loads. The resistors ($10K$) in series with the capacitors which couple the signals to the $1K$ mixing resistors provide a minimum isolation between channels of 46 db. Dependence on tube characteristics for proper matrixing is eliminated with this arrangement, since a change in tube characteristics is reflected equally in both plate and cathode circuits, and a readjustment of the input amplitude control returns operation to normal.

The Q , I , and Y signals are fed through a series of amplifier stages where bandwidth-limiting is accomplished by phase-corrected filters having characteristic responses as shown in Fig. 7. The filters are of 75Ω characteristic impedance driven by cathode followers located within the unit. Equalization of phase delay introduced by the bandwidth-limiting filters in the three channels is provided by artificial delay lines in the I and Y channels. The delay lines used are the unitized plug-in type of 1200Ω characteristic impedance and are used as plate loads in conventional pentode amplifier stages. Employing such a combination of low impedance filter—high impedance unitized delay line has distinct advantages: (1) subchassis containing large quantities of delay cable are eliminated, and (2) adequate phase-correcting of low impedance filters is an established fact and reliable filters are more readily obtained.

Q and I signals are converted into subcarrier sidebands of chrominance information by two modulators of the type described earlier in this article. Evaluation of the operation of this type of modulator circuit reveals it to have the degree of stability necessary in equipment of broadcast quality.

The FCC specifies that the subcarrier burst shall reside on the "back porch" of the sync signal and shall be free of pedestal. Here again the 6BN6 tube with its negative G_m was found to be useful. (See Fig. 8A) By connecting the accelerator of one tube to the plate of another tube, the pedestal cancels, resulting—in effect—in the G_m of the tube with the subcarrier injected being gated from a finite value to zero, thus performing the gating function. The gating pulse is formed by delaying the sync pulses with a delay line to establish the proper time and then

(Continued on page 38)

Fig. 8. Schematic diagrams and waveforms for (A) the color synchronizing burst generator, and (B) the signal component mixing arrangement.

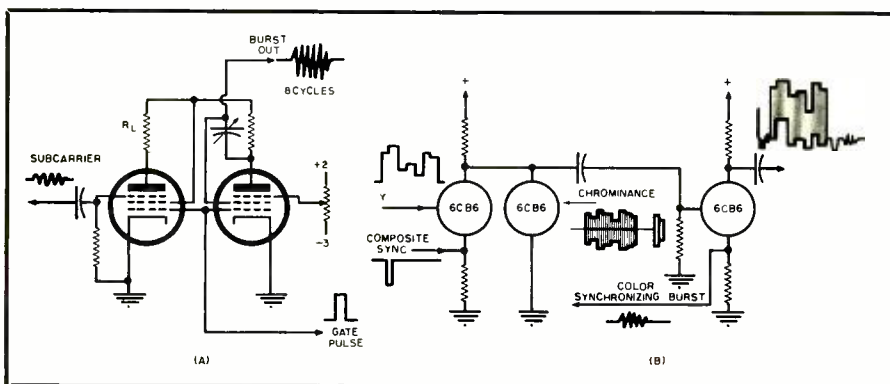

TAPERED WAVE GUIDE ADAPTERS

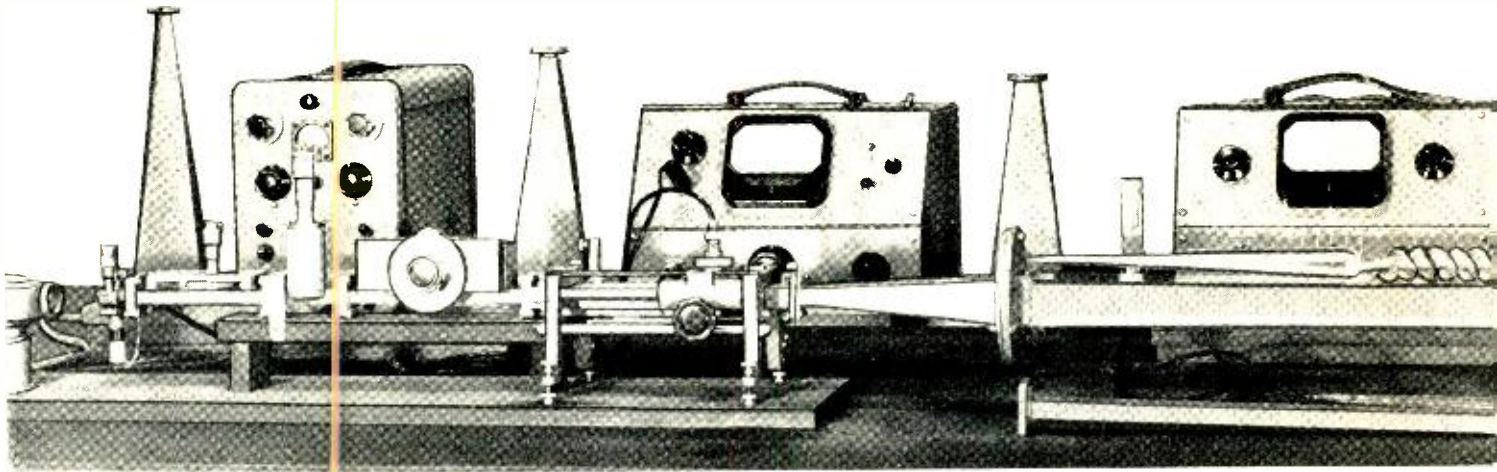

Fig. 1. Application of an adapter to permit use of a standard 3-cm. test setup on the 10-cm. band.

WAVE guide adapters tapering from a small to a larger wave guide size make it possible to utilize a single piece of microwave apparatus or a microwave system on bands other than the primary band for which the equipment was designed. There is sufficient flexibility and versatility in such adapters to permit readily available and well designed X-band (10,000-mc.) energy sources and apparatus to reach the more recent and more cumbersome wave guide system requirements of u.h.f. television.

Conversely, adapters tapering from a large wave guide size—where microwave energy can be more easily generated from conventional tubes and power supplies—to a smaller wave guide size permit useful harmonic or higher frequency components to be filtered through at frequencies where existing tubes and facilities are either too expensive or nonexistent.

The primary purpose of tapered wave guide adapters is to make one set of apparatus serve many bands of operation. Uses will suggest themselves through microwave research, development and trouble-shooting. The author has found these adapters to be extremely useful in the following applications:

1. An available high microwave frequency may be employed as a satisfactory substitute for an unavailable or unfeasible lower microwave frequency by changing from a small-size wave guide utilizing the dominant energy mode to a larger-sized wave guide making use of a multi-mode method of transmission.
2. Low microwave frequency test equipment, such as a microwave calorimeter or dummy load can be used with microwave energy from any high frequency source.

3. High frequency components of a low frequency microwave energy source may be separated and used.
4. All frequencies below cutoff frequency for the smallest dimension of the wave guide taper may be filtered out of a signal source.
5. An adapter may serve as an electromagnetic horn or directive antenna system.
6. An adapter setup can function as a high frequency bandpass filter in addition to being a low frequency band-elimination filter.
7. The mode or pattern distribution of microwave energy in a wave guide can be changed.

Shown in Fig. 5 is a set of wave guide adapters for use with a commercial microwave calorimeter. These adapters have been used to extend performance from 1000 to 60,000 mc. and even beyond. Wherever adapters have been furnished as accessories to such

test equipment, they have very frequently been "borrowed" or converted for other uses. Now they are important in their own right for many applications other than that for which they were originally intended.

Modes of Operation

Techniques for introducing energy into a wave guide together with the shape and dimensions of the wave guide in relation to the wavelength or frequency determine the distribution of the electric and magnetic fields therein. The distribution of these electric and magnetic fields determines the "mode" of operation.

A mode is a pattern which the energy will form and follow through the wave guide. In any single wave guide of uniform dimension, there is always one dominant mode. The dominant mode, by definition, is the mode with the lowest cutoff frequency which can exist in the

By **SAMUEL FREEDMAN**

Chemalloy-Electronics Inc.

Properly designed tapered sections permit transitions from one wave guide size to another with a low VSWR.

Fig. 2. Electric and magnetic field distributions for $TE_{0,1}$ mode in rectangular wave guide.

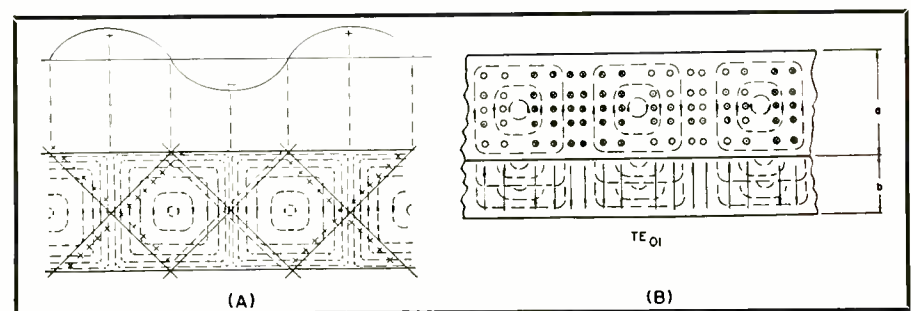

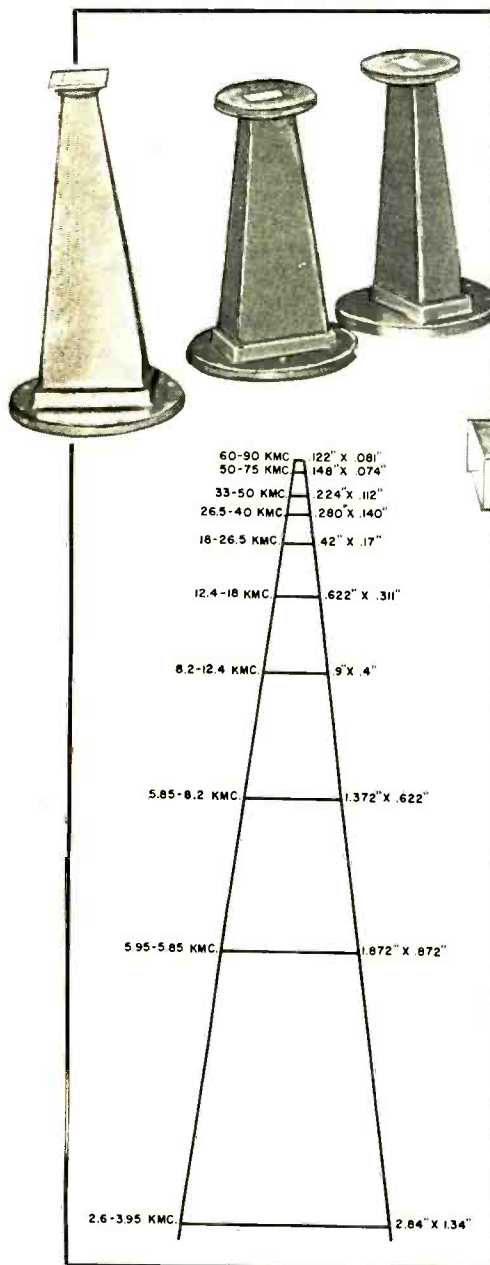

Fig. 5. Wave guide adapters for use with a calorimeter.

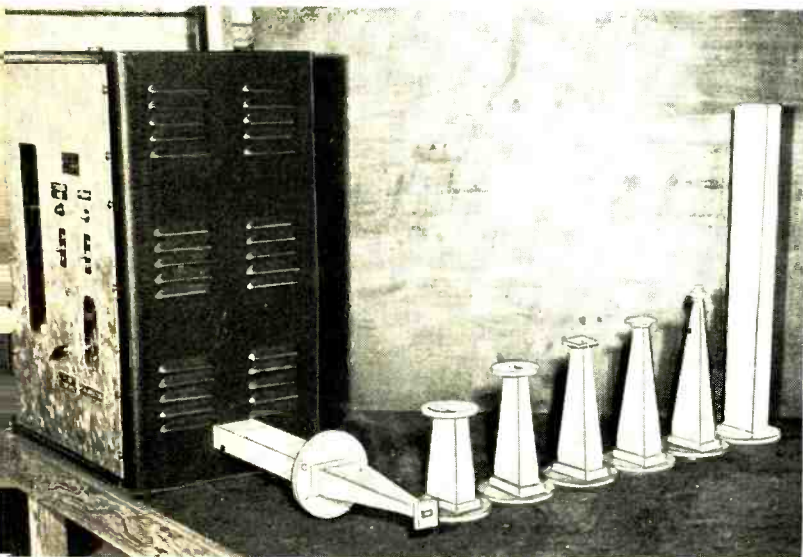

Fig. 3. Joining metal pieces to form a tapered wave guide adapter.

wave guide. It does not depend on how the wave guide is excited but only on its geometrical shape.

Modes are either transverse electric (*TE*) or transverse magnetic (*TM*), with numerical subscripts which depend on the dimensions of the wave guide and the frequency. In the case of rectangular wave guides, the first subscript indicates the number of half-wave patterns of electric lines or magnetic loops which exist across the height of the wave guide. The second subscript indicates the number of half-wave patterns across the width. Merely doubling the frequency without changing the wave guide dimensions, or doubling the wave guide dimensions without changing the frequency, will double the number of patterns or modes which may

Fig. 4. Taper angle and scale for adapters between 2600 and 90,000 mc.

exist, changing the mode of operation.

An adapter does not change the frequency. It only changes the mode from dominant or multimode at highest frequency to a higher order of mode at lowest frequency.

To lay out and describe fully the possible modes and how they exist dynamically in a wave guide at microwave frequencies is obviously impractical in this article. When the maximum rectangular interior width of a wave guide exceeds a half-wavelength and is less than a full wavelength, it is said to be operating in its dominant TE_{01} mode. The dominant mode will be described by referring to Figs. 2A and 2B.

Figure 2A shows the electric field component canceling out at the walls of a wave guide while reinforcing in the center. It also shows the magnetic field distribution, and indicates that the field is zero in the center and maximum at the radius. Each half-wavelength corresponds to one pattern. The illustration shows two half-patterns and two full patterns aggregating one-and-one-half wavelengths within the wave guide section. The sine wave corresponds to the electric field distribution in the center of the wave guide; the electric field is always at right angles to the magnetic field.

Figure 2B shows the electric and magnetic field distributions in a wave guide operating in the TE_{01} transverse electric mode, as the electric field is perpendicular to the axis of the wave guide. The first subscript (0) indicates that zero half-wave patterns exist across the cross section of the guide along one dimension. The second subscript (1) signifies that one half-wave pattern exists across a dimension at right angles to the first.

(Continued on page 33)

Fig. 6. A collection of typical wave guide adapters.

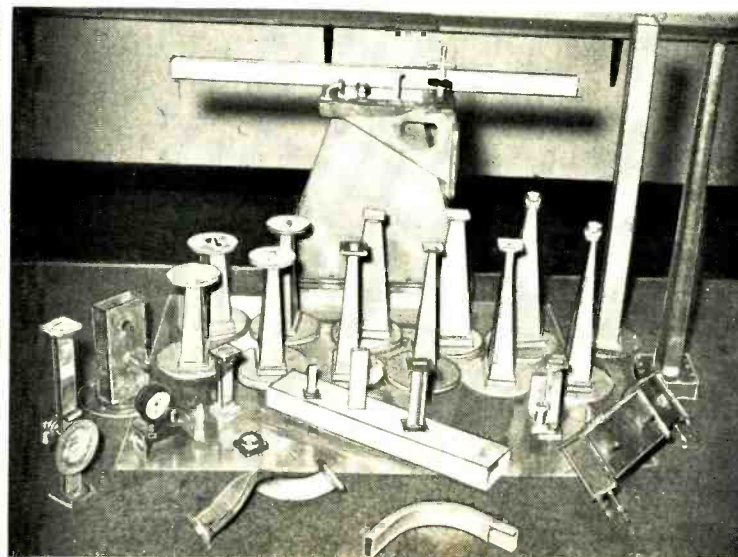

VISUAL DEMODULATOR FOR V.H.F.-U.H.F.

By

DUANE M. WEISE

Chief Engineer, KOMU-TV
University of Missouri

This TV monitor employs a superheterodyne receiver with i.f. bandshaping circuits to give a VSB characteristic.

A TELEVISION visual monitor is analogous to AM and FM station monitors in that it must afford both a means of determining the quality of the transmitted signal and an indication of percentage modulation. The visual monitor, or demodulator, should therefore provide a signal for the visual presentation of the signal actually being radiated and at the same time yield a visual indication of the zero carrier level from which actual percentage modulation levels may be determined.

Figure 1 illustrates the idealized picture transmission-amplitude and, conversely, the transmitter-attenuation characteristics with the limits which fall within FCC and RETMA specifications. In general, most television transmitters closely duplicate the ideal characteristic. Figure 3 compares the system response for: (A) double-sideband transmitter and double-sideband receiver, (B) a double-sideband transmitter and vestigial-sideband receiver, (C) vestigial-sideband transmitter and

double-sideband receiver, using a simple diode detector, and (D) a vestigial-sideband transmitter and vestigial-sideband receiver of the superheterodyne type.

VSB Transmission

Certain transient phenomena are inherent in the characteristics of vestigial-sideband (VSB) transmission. Figs. 3A and 3D, for example, illustrate the over-all system response to a unit step function for a double-sideband (DSB) and a VSB system. It should be noted that there are four characteristics distinguishing the VSB system: (1) a low-frequency smear component is present as the unit step returns to unit level; (2) a leading white or anticipatory transient exists; (3) the rise time is increased; and (4) high-frequency overshoot and ringing are present. These transient effects are apparent if an ideal receiver characteristic is employed. It should be

**Formerly project engineer at General Electric Company.*

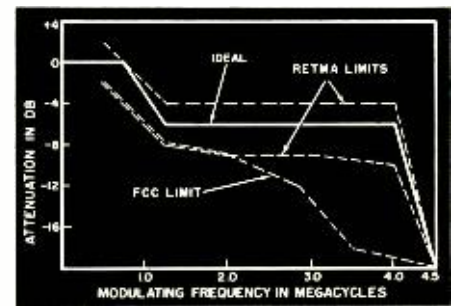

Fig. 1. Transmission characteristics.

stressed that a receiver which does not approximate the ideal VSB response will not, in general, exhibit the expected transient response and will tend, therefore, to indicate that the signal being radiated is better than it really is.

In television terms, a certain amount of smear, ringing, and anticipatory overshoot are indigenous to VSB transmission. These effects are readily understood as the transient effects of VSB transmission become familiar.

Quite often, a simple diode detector is employed for monitoring visual transmission. It should be pointed out that the detector is a double-sideband unit and will have a frequency response to the modulating frequencies of the VSB transmitter as illustrated by Fig. 3C. Again it is quite apparent that the actual response does not give a true indication of the quality of the signal being transmitted. The high frequencies, which are down 6.0 db, will cause any high frequency overshoot or ringing to be minimized and, conversely, will cause

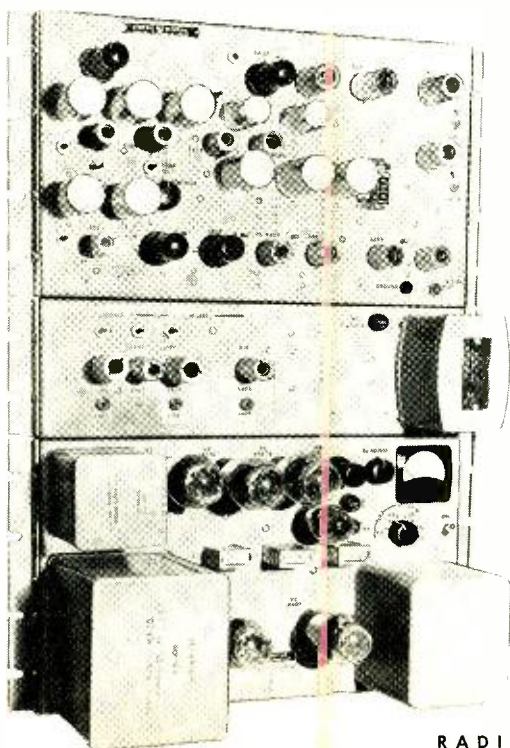
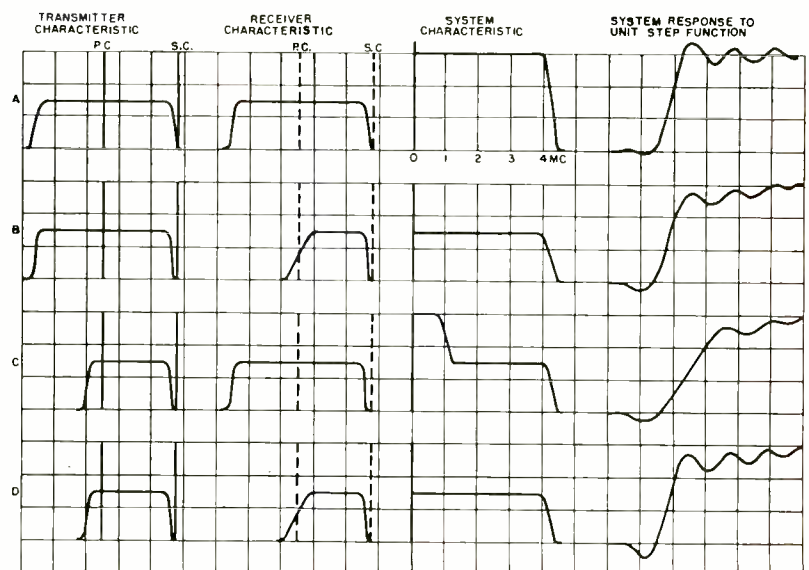

Fig. 2. Over-all view of demodulator assembled for rack mounting.

Fig. 3. Comparison of system response for various types of operation.



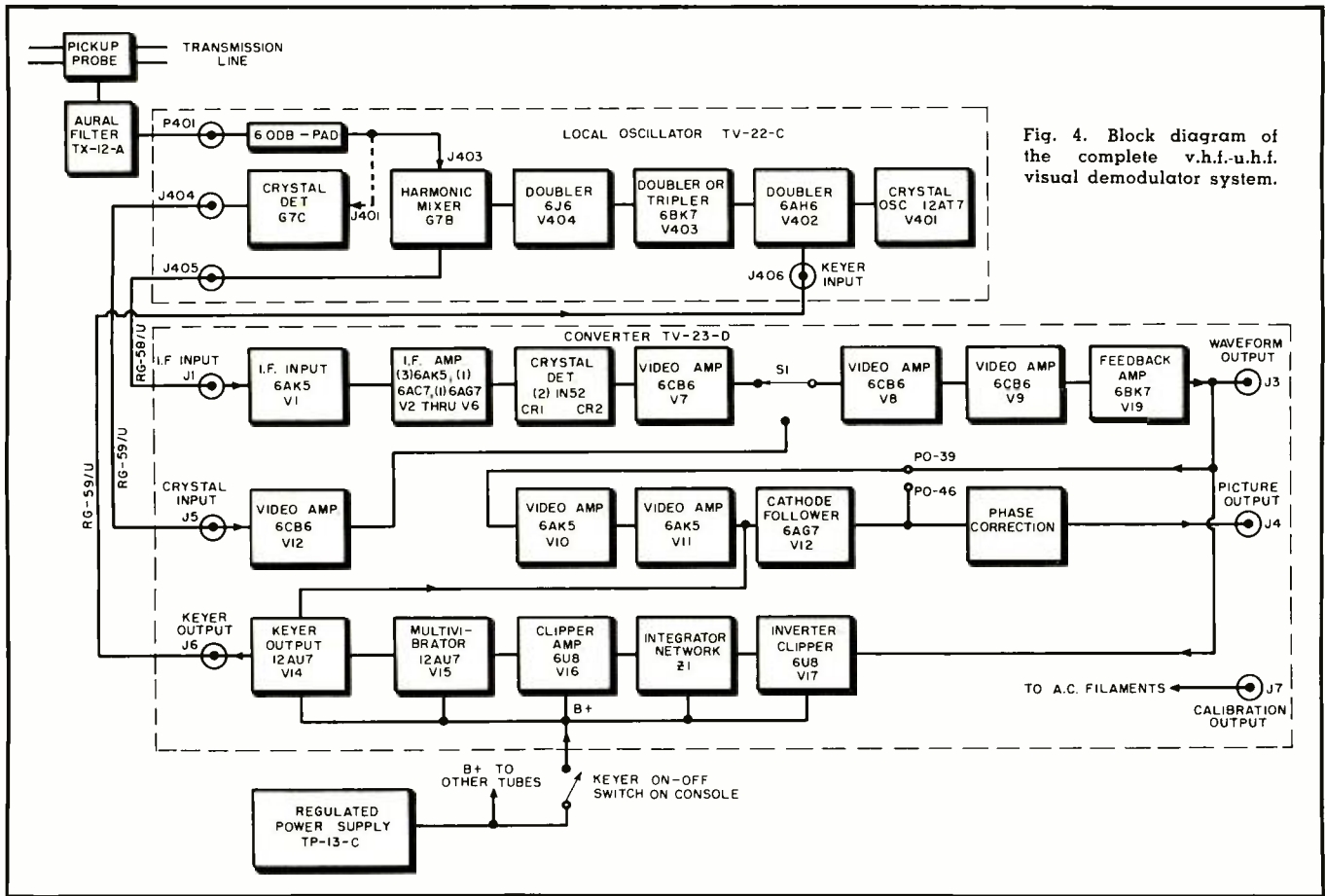

Fig. 4. Block diagram of the complete v.h.f.-u.h.f. visual demodulator system.

low frequency smear to be emphasized.

The ideal receiver characteristic for vestigial-sideband transmission should be such that when the over-all transmitter-receiver system is considered the frequency response is flat. To achieve this over-all response, the receiver response should be similar to that shown in Fig. 3D. An analysis of this response will indicate that the position of the visual carrier is of considerable importance. Experimental data have shown that deviations of the visual carrier position on the ideal receiver characteristic greater than ± 20 kc. cause extraneous smear and ringing in the demodulated signal. It is for this reason that a crystal-controlled local oscillator is employed in the *General Electric* demodulator.

Design Considerations

In the initial stages of developing a means of accurately presenting the actual transmission from a television transmitter, much thought was given to the various methods which might be utilized. The methods which received consideration were the following: (1) direct monitoring of the r.f. envelope on the deflection plates of an oscilloscope; (2) a superheterodyne receiver employing r.f. bandshaping circuits for a VSB characteristic; (3) a superheterodyne receiver employing i.f. bandshaping circuits for a VSB characteris-

tic; (4) direct r.f. detection employing video bandshaping circuits for a VSB characteristic. The third method, using staggered-tuned i.f. stages, was selected.

Before discussing the actual design, in brief review, the functions of the demodulator are such as will provide the following desiderata: (1) a VSB RETMA ideal receiver response characteristic, (2) a DSB response characteristic for measuring transmitter amplitude-vs.-frequency characteristic required for FCC proof-of-performance tests, (3) a means of accurately indicating modulation levels, (4) a video signal for waveform monitoring, and (5) a video signal for picture monitoring.

To perform these functions, employing the i.f. means of bandshaping, two chassis were developed. The center chassis shown in Fig. 2 contains the crystal-controlled local oscillator unit, and the top chassis contains the i.f. and video stages as well as the keyer pulse-forming network for indicating zero r.f. carrier level. The bottom chassis is the associated power supply unit, and is entirely conventional. Reference to Fig. 4, a block diagram of the units, will indicate their interconnection.

The local oscillator units employed are essentially similar for v.h.f. and u.h.f. operation. A crystal-controlled tuned-plate oscillator stage drives several succeeding frequency-multiplier

stages. The crystal operates on its third mode over a frequency range of 30 to 45 mc. and has a frequency stability of .0025%. High crystal frequency stability is essential in order to maintain the visual carrier at its 50% position on the receiver response characteristic. One or more frequency-multiplier stages follow the crystal oscillator stage, with tuning accomplished by using variable slug-tuned coils and removable capacitors across the coils. Separate local oscillator chassis are utilized for the low band, high band, and u.h.f. band of frequencies. These differ in the number of multiplier stages required to obtain a signal 25 mc. (i.f. frequency) above the r.f. visual carrier frequency.

In addition, the method of mixing the r.f. carrier with the local oscillator signal distinguishes the v.h.f. and u.h.f. local oscillator chassis. The v.h.f. units, low and high channel, use a 6AS6 tube for mixing, the local oscillator signal being coupled into the suppressor grid circuit while the r.f. carrier is fed in at the grid. This method provides high-impedance isolation between the local oscillator and carrier inputs and the i.f. (25-mc.) output.

The u.h.f. unit uses a G7B germanium diode as a harmonic mixer (doubler). In this way, the final multiplier stage of the local oscillator is required to operate only over an ap-

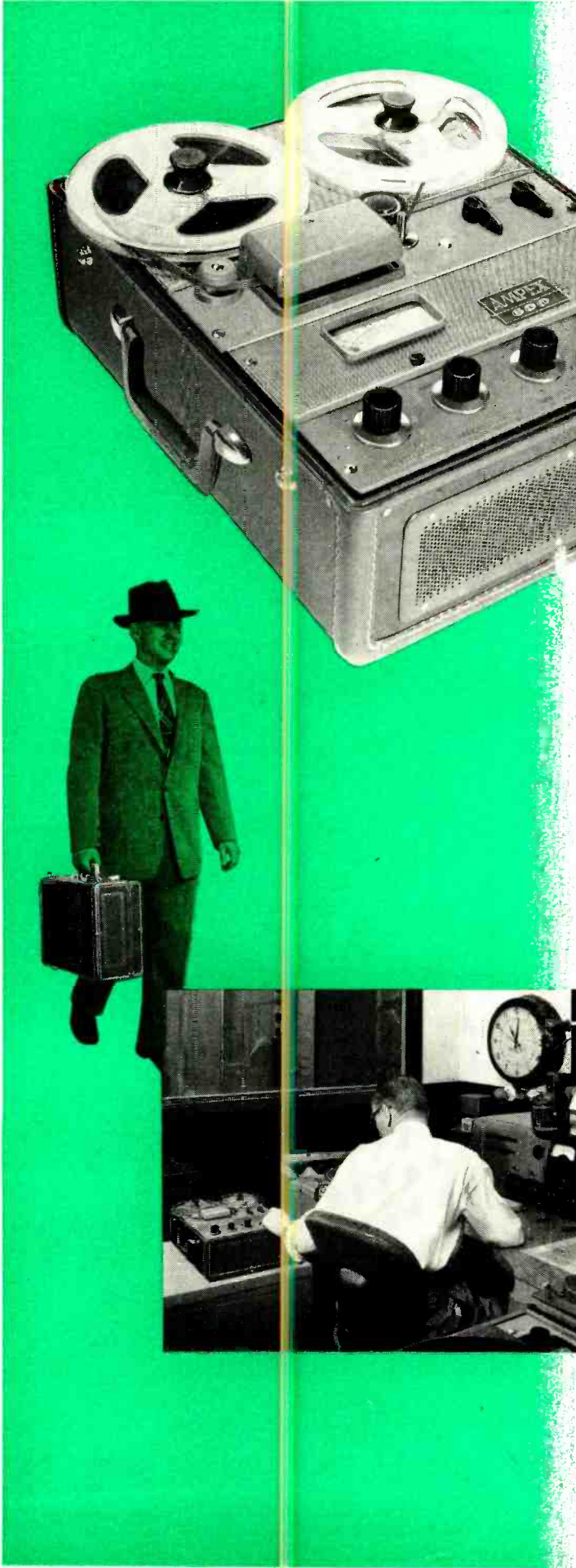

an Ampex tape recorder for as little as \$498

(\$545 with portable case as shown)

the new **AMPEX**
600

At a price that's a real surprise, here is the kind of performance that has made AMPEX the supreme name in tape recorders. The new Ampex 600 has been simplified to reduce its size and price. But it retains full Ampex precision and performance.

As a portable recorder, the Ampex 600 is in a class by itself. It weighs only 28 pounds. You can carry it anywhere. The recordings you make "on location" will match those made on the finest studio equipment.

As a studio recorder, the Ampex 600 out-performs many others twice its size. It serves ably in all these needs: studio recording—line recording—dubbing and editing—broadcast playback.

To assure long service, major components of the Ampex 600 have been subjected to tests equaling more than 10 years normal use. An Ampex pays for itself.

Performance

- 40 to 15,000 cycles at 7 1/2 in/sec.
- Signal-to-noise ratio over 55 db.
- Flutter and wow less than 0.25%
- 3 heads for monitoring tape while recording

For further specifications, write today for descriptive bulletin to Dept. T-1701



934 Charter Street • Redwood City, California
Distributors in principal cities; Canadian distribution by
Canadian General Electric Company

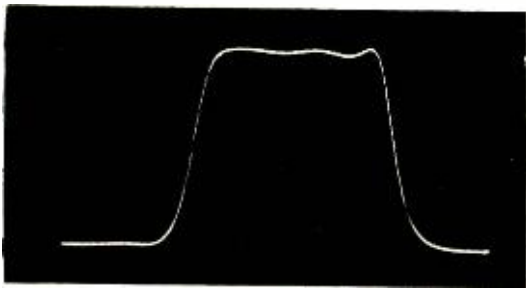

Fig. 5. I.F. frequency response with half voltage points at 19 and 25 mc.

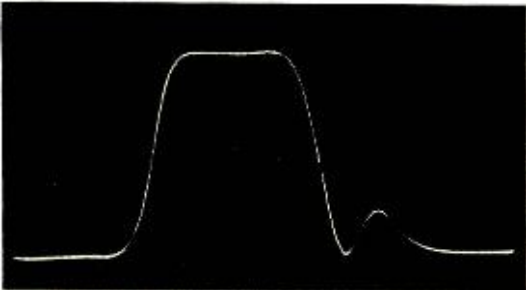

Fig. 6. I.F. frequency response with aural carrier traps in the circuit.

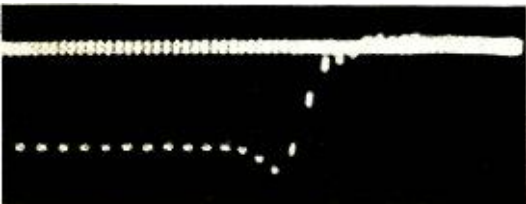

Fig. 7. Over-all transient response of converter to double-sideband signal

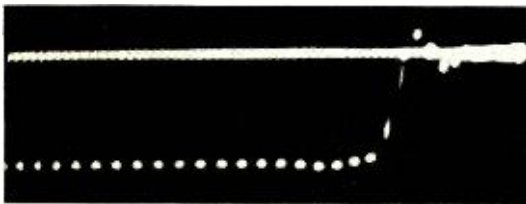

Fig. 8. Transient response after phase correction network for VSB receiver.



Fig. 9. Video output to illustrate use of a zero carrier reference pulse.

proximate frequency range of 250 to 460 mc. for conversion of the u.h.f. carrier to the i.f. frequency. Although harmonic mixing considerably reduces conversion efficiency, the location of the demodulator relative to the transmitter enables sufficient r.f. carrier signal to be coupled into the mixer so that signal conversion efficiency is not an important factor in the over-all performance. The r.f. carrier signal is d.c. coupled to the crystal mixer, and the local oscillator signal is a.c. coupled to the mixer through a high impedance.

I.F. and video stages are identical in the v.h.f. and u.h.f. units. The overall i.f. frequency response characteristic shown in Figs. 5 and 6 is obtained by the staggered-tuned i.f. circuits, which include a trap for shaping the slope of the curve near the carrier. Capacity loading of the i.f. circuits provides good stability and reduces detuning effects due to tube replacement. Refer to Fig. 10 for the discussion which follows.

Circuit Details

The input to the i.f. amplifier stage, V_2 , is tuned for approximately 19.5 mc. and is capacity-loaded for stability. A trap (L_2 and C_{13}) in the plate circuit of V_2 is tuned to approximately 25.8 mc. to produce a linear slope from the carrier towards zero. The input circuit to V_4 is tuned to approximately 24.5 mc., and is the most sensitive circuit to capacity change because its tuning determines the position of the carrier on the slope of the i.f. response curve. However, tests have shown that 6AK5 tubes within specification limits do not seriously impair the accuracy of this tuning inasmuch as swamping capacity is included to make the circuit more stable. The input circuit to V_5 is tuned to approximately 23 mc. and the input to V_6 to approximately 21 mc.

JAN specifications allow for considerable variation in the input capacity of 6AG7 tubes (V_6). Therefore, this circuit is tuned to that section of the band which least affects the transient response. The 6AG7 buffer-amplifier (V_6) has a wide-band untuned output circuit feeding the crystal detector. A removable i.f. trap attenuates the residual sound carrier to prevent overloading the 6AG7, which is operating at its maximum linear output.

The second detector consists of two crystals (CR_1 and CR_2) paralleled to give a lower forward resistance and, therefore, better linearity. A calibration chart is provided with each set of crystals to enable accurate adjustment of percentage modulation.

An i.f. rejection filter ($L_6, L_7, C_{68}, C_{69}, C_{105}$) in the first video amplifier input is a low-pass filter which attenuates frequencies above 15 mc. Degeneration in the first video amplifier (V_7) gives good linearity, and shunt plate compensation gives a frequency response which is flat to approximately 7 mc. A removable trap in the second video amplifier input further attenuates any aural carrier signal which may be present. The i.f. and video traps combined attenuate the aural carrier at least 20 db (see Fig. 6). The demodulator employs a directional pickup probe between transmitter and diplexer, and the additional 28 or 30 db of aural carrier attenuation afforded by the diplexer prevents the aural carrier from interfering with the picture and waveform displays. If it is desired to monitor after the diplexer, a hybrid-type filter (TX-12-A) has been developed which provides an additional 20 db of aural carrier attenuation in the u.h.f. band. A feedback output amplifier provides 1.4 volts peak-to-peak when terminated in 75 ohms.

Video amplifier stages, V_{10}, V_{11} , and V_{12} (Fig. 4), provide an isolated video signal for picture monitoring in which the zero reference pulse has been removed. Amplifier V_{10} uses shunt plate compensation for improved frequency response. A common plate load is used for the second picture video amplifier (V_{11}) and the pulse reinsertion tube (V_{14}). The 6AG7 cathode follower (V_{12}) has a phase corrector network in the picture output designed to minimize the effect of phase shift in the demodulator due to phase distortion inherent in VSB reception. When the unit is used to measure a suitable modulated square wave from a perfect DSB transmitter, the network is adjusted for minimum anticipatory overshoot and a constant axis separation. Thus, any preceding white and following smear which may be observed on a VSB transmission will be due to the cutoff characteristic of the transmitting

(Continued on page 38)

Fig. 10. Schematic diagram of the i.f. stages and second detector of the demodulator.

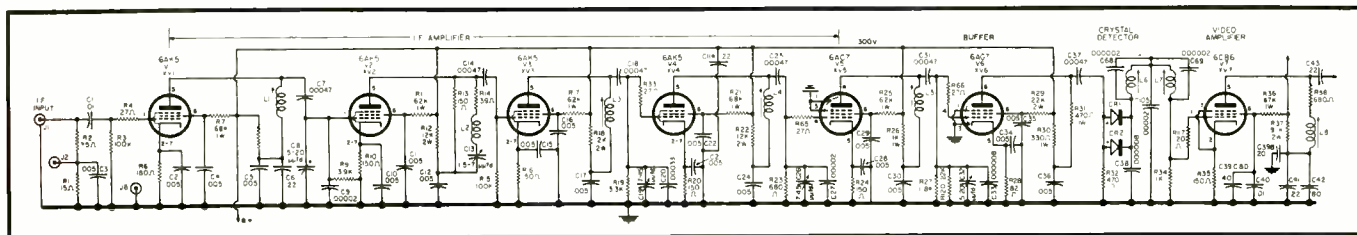

NEW

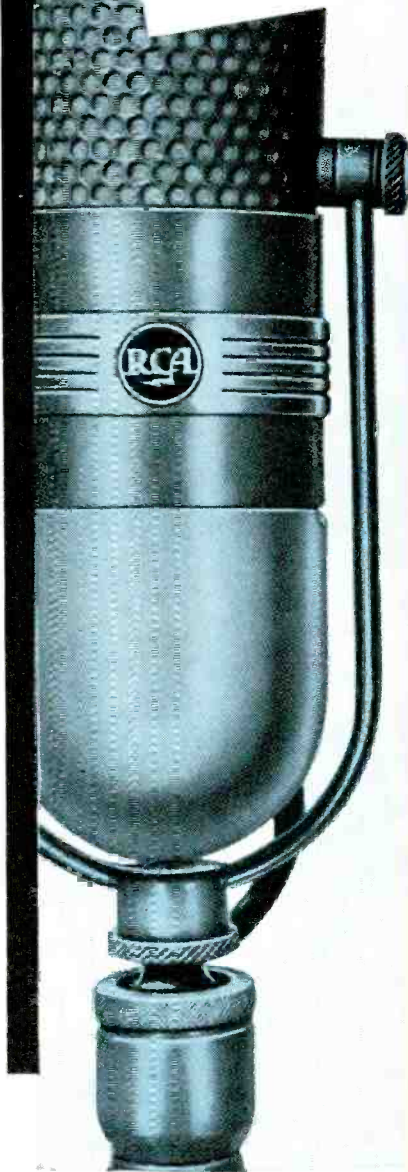

BROADCAST
AUDIO
EQUIPMENT
for
AM • FM • TELEVISION

- | | |
|------------------|----------------|
| MICROPHONES | RACK EQUIPMENT |
| CONSOLES | TURNTABLES |
| CUSTOM EQUIPMENT | RECORDERS |
| AMPLIFIERS | SPEAKERS |



AUDIO catalog for Broadcasters

AM
FM
TV

THIS 146-PAGE CATALOG contains "straight-to-the-point" information about all RCA audio equipment and accessories designed for broadcast and television station operations. The book covers more than 200 professional audio items . . . and includes data, specifications, response curves, typical station equipment lists,

and studio layouts. It's authoritative. It's complete. It's the only book of its kind in the industry. For your copy of the RCA Audio Catalog, ask your RCA Broadcast Sales Representative. Or write Dept. 1-157 RCA Engineering Products, Camden, N. J., on your station letterhead. In Canada, write RCA Victor Ltd., Montreal.



RADIO CORPORATION of AMERICA
ENGINEERING PRODUCTS DIVISION
CAMDEN, N.J.

GLOBAL COMMUNICATIONS SYMPOSIUM

Technical and administrative problems were discussed and many communications facilities were described at this Symposium.

ABOUT 500 engineers gathered at the Hotel Statler, Washington, D.C., on June 23-25 to participate in the first Global Communications Symposium to be sponsored by the IRE Professional Group on Communications Systems (PGCS). Highlights included a broadcast by the Voice of America direct from the banquet hall, and a series of inspection trips to nearby radio facilities such as the U. S. Navy radio transmitter at Annapolis, the U. S. Army and National Bureau of Standards radio facilities, U. S. Air Force Global Communications at Andrew Air Force Base (GLOBECOM), the Army Communications Center in the Pentagon, and NBS Station WWV.

No report on the 19 technical papers will be given, as these papers will be printed in full in the Transactions of the PGCS. The titles and authors of the papers are listed below. Members of PGCS will receive copies of the Transactions; others who are interested should contact The Institute of Radio Engineers, Inc., 1 East 79th Street, New York, N. Y., for copies.

Banquet Program

An unusual feature of the banquet program was a series of talks by representatives of several national women's organizations. They emphasized the importance of the integrity of global communications, and made pleas for

educational TV facilities and better TV programming.

The main banquet address was presented by Mr. George W. Gilman, Director of Systems Engineering, *Bell Telephone Laboratories*. His subject was "Research and Development in Global Communications," with primary emphasis on the revolution taking place in the submarine cable art as a result of the development of a practical submerged amplifier. He briefly traced cable development from the first cable, capable of handling about two words per minute, to the Key West—Havana link using six submerged repeaters and providing an effective bandwidth of 100,000 cycles. The repeaters in this cable have been in continuous operation for four years, and are expected to continue to work for at least 20 years. A link now planned between Newfoundland and Scotland will be completed within two years and will have an effective bandwidth of nearly 150,000 cycles, carrying 35 telephone channels. In addition, present cables are being rejuvenated by the addition of submerged amplifiers. More detailed information on submerged amplifiers was given in two of the technical papers presented at the daytime sessions.

Mr. Gilman also discussed global radio, emphasizing that areas of possible improvement include better antennas for reducing radiation and

reception in unwanted directions, and the more effective organization and use of existing radio facilities. He outlined three possibilities for the use of higher frequencies for global radio. The first involves high power and high gain antennas to provide strong signals up to 1000 miles at frequencies just above the high frequency band. The second is to use the u.h.f. and s.h.f. bands, again with high power and large antennas, for distances up to 200 miles; this is the basis of the North Atlantic Radio Communications plan (NARCOM). The third involves the use of conventional microwave relay systems with stations perhaps 30 miles apart.

Luncheon Talks

In a luncheon talk, titled "Development of Civil Global Communications Systems," Mr. Haraden Pratt traced the development of intercontinental telegraph systems, bringing out the point that submarine cables were nearly abandoned as impractical after several early failures. He described a worldwide overland open-wire telegraph system which was well on the way to completion when the first successful submarine cable was placed in operation. The overland system was immediately abandoned.

A talk on "Global Communications Systems of the Armed Services" was given by Major General R. V. D. Corput, Jr., Director, Communication-Electronics, J. C. S., Department of Defense. He sighted one example in the Civil War and one in World War II to show that inadequate communications in wartime can lead to disaster, while adequate communications can greatly assist in an overwhelming victory, as at the battle of Midway. There are problems of channel utilization which are peculiar to military systems, he said. For example, the circuits between Washington and all overseas theater commanders may not be justified on the basis of traffic load alone, but must be immediately available in case of war. Such allocations would appear wasteful to one monitoring these channels, but are justified for national defense.

Polyplex Exhibit

It would be impossible to describe all of the exhibits adequately in the

(Continued on page 35)

List of technical papers which were presented at the Symposium.

Administrative Aspects of Telecommunications. William A. Porter, *Office of Defense Mobilization*
The International Telecommunication Union and Global Communications. Francis Colt de Wolf, *Department of State*
International Radio Frequency Management. Paul D. Miles, *Federal Communications Commission*
The Organization and Function of the C.C.I.R., Edward W. Allen, Jr., *Federal Communications Commission*
Improving Frequency Management to Facilitate Global Communications. Donald R. MacQuivey, *Department of State*
British Global Communications. Col. A. H. Read, *British Embassy*
Global Marine Communications. E. M. Webster, *Federal Communications Commission*
Department of the Army Command Communications. William F. Spanke, *Office of the Chief Signal Officer*
Organization and Operation of the Naval Communication System. Cdr. Guy M. Neely, USN (Ret.), *Office of the Chief of Naval Operations, Department of the Navy*
USAF Strategic Communications System. Col. George M. Higginson, *Directorate of Communications, Hq USAF*
Overseas Air Traffic Control and Meteorological

Circuits of the Civil Aeronautics Administration. Frank J. Cervenka, *Civil Aeronautics Administration*
International Planning of Global Communications for Aviation. Hector R. Adam, *International Civil Aviation Organization*
Global Air/Ground Radiotelephone Communications. W. W. Lynch, *Pan-American World Airways*
World-Wide Radio Propagation Predictions. A. H. Shapley, *National Bureau of Standards*
Frequency Propagation Forecasting for World Air Route Operations. C. A. Petry, *Aeronautical Radio, Inc.*, and Lawton S. Meaker, *Directorate of Communications, USAF*
Recent Advances in International Radio Communication. Irving K. Given, *RCA Communications, Inc.*
Global Public Telephone Communications. D. D. Donald, *American Telephone and Telegraph Company*
Radio Telegraph Transmitters and Polyplex Transmission in the American Cable and Radio System. Christopher Buff and Fullerton D. Webster, *Mackay Radio and Telegraph Company*
Impact of Submerged Repeater on Global Telegraphy. C. S. Lawton, *Western Union Telegraph Company*

**WHERE POWER
IS VITAL**

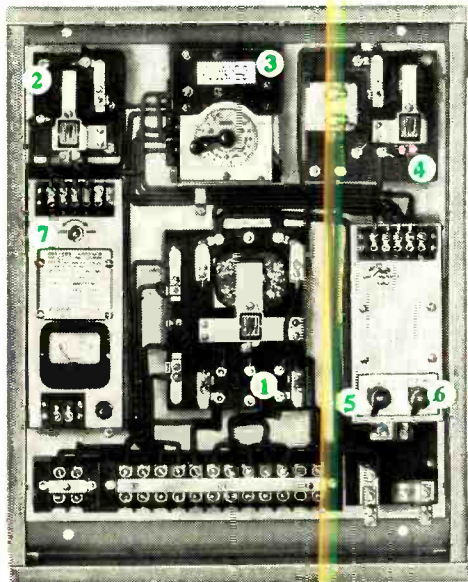

**This ASCO[®]
Automatic Transfer Switch Panel
does 24-hour guard duty**

ASCO Automatic Transfer Switches provide

continuous adequate-voltage power...when installed with New or Existing Emergency Power Supplies

To assure continuous power an **ASCO Automatic Transfer Switch (1)**, stands ready to transfer the load to an emergency source within 2 to 5 cycles when normal power fails. Once the normal source is in proper operating condition, the load is automatically restored.

To assure adequate-voltage power, the voltage sensitive **Close Differential Relay (2)**, operating with the Transfer Switch, provides transfer on a 5% differential in power supply voltage (less, if required).

Other Features:

Timer (3)—Provides 3-5 second delay on engine starting; 0-13 minute adjustable delay on restoration to normal; 2 minute delay on stopping engine.

Lockout Relay (4)—Prevents transfer until electric plant rated voltage and frequency are attained.

Test Switch (5)—Simulates normal failure.

Stand-by Switch (6)—Disconnects engine start circuit and permits independent operation of emergency generator set.

Trickle Charger (7)—(With ammeter and 5 ampere fuse). Keeps emergency electric plant starting batteries charged.

This complete panel may be installed with your new emergency power supply, or may be wired into an existing installation. ASCO Transfer Switches are available up to 1,000 Amperes, 750 Volts, A-C or D-C, with modifications as required.

ASCO also designs and manufactures a complete line of Electro-magnetic Controls including Solenoid Valves, Remote Control Switches, Contactors, Relays, and Complete Control Panels.

For further information on ASCO Emergency Generator Controls, see our booklet, "When Normal Power Fails", with essential engineering data. Write today for your free copy.



Automatic Switch Co.

385-R Lakeside Avenue, Orange, N. J. • ORange 2-5300

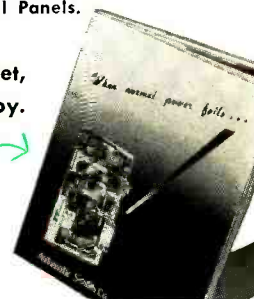

NEW PRODUCTS

BROADBAND ADAPTER

Low VSWR is achieved in the new Type 355-A waveguide-to-coaxial adapter which has been announced by *Poly-*

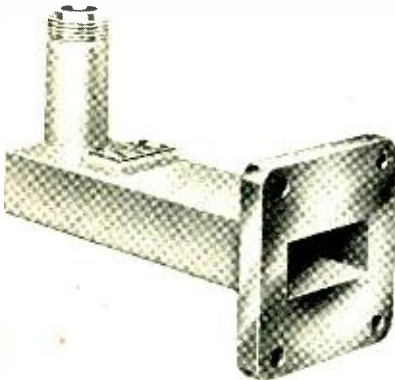

technic Research & Development Co., Inc., 202 Tillary St., Brooklyn 1, N. Y. The maximum VSWR is less than 1.15 between 8.50 and 10.00 mc., and less than 1.30 from 7.05 to 8.50 mc. Overall length of the wave guide section has been reduced 41% compared with the previous model.

Type 355-A consists of a probe inserted perpendicularly into the broad face of a wave guide section at a position effecting optimum impedance match. The input end of the RG-51/U wave guide section is fitted with an AN-UG 51/U cover flange.

FREQUENCY TIME COUNTER

Direct measurement of frequency up to 150 kc. can be made with the Model 3149 frequency time counter by means of five electronic counter decades that

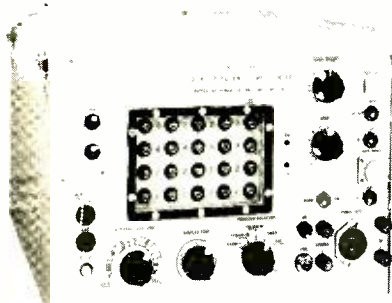

count the cycles of the unknown for an exact crystal-controlled interval of time. Low frequencies are measured

by counting time-base pulses occurring during 1 or 10 cycles of the unknown, and time intervals may be measured to the nearest 0.00001 second.

Announced by *Potter Instrument Company, Inc., 115 Cutter Mill Rd., Great Neck, N. Y.*, the 3149 is a general-purpose instrument for making direct measurements under field conditions with laboratory type accuracy and complete reliability. Designed around military specifications, it is housed in a reinforced dripproof cabinet of extra heavy gauge aluminum.

SUBMINIATURE TRANSFORMERS

Consisting of 32 models, the new line of subminiature transformers introduced by *Texas Instruments Incorporated*

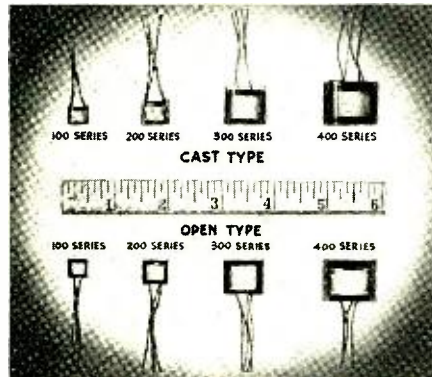

rated has been especially designed for transistor and other miniaturized circuit applications. Dimensions range from $\frac{3}{8}$ " x $\frac{3}{8}$ " x $1\frac{1}{16}$ " to $\frac{3}{4}$ " x $\frac{7}{8}$ " x 1", with power capabilities from less than 1 mw. to over 100 mw.

These transformers are suitable for use in the audio and ultrasonic frequency ranges. They are supplied in four different-sized series, with each series having input, interstage, choke, and output models. Each of 16 basic units is manufactured in both open type and cast construction. For further information, write to *Texas Instruments Incorporated, 6000 Lemmon Ave., Dallas 9, Texas.*

FREQUENCY STANDARD

Recently announced by the *New London Instrument Company*, the Model 701 frequency standard provides a source of highly stabilized frequencies covering the range from 10 kc. to 50

mc. at intervals of 10 kc., 100 kc., or 1 mc. Stability of one part in 10^7 per 24 hours has been achieved by a unique method of temperature stabilization.

Frequency dividers and multivibrators are used to develop the range of

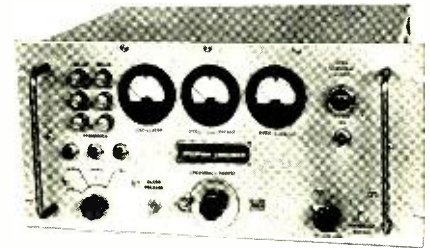

frequencies available. A warning light is provided to give an indication of temperature stabilizing oven failure, and there is a fine frequency control for adjusting the standard oscillator frequency at 1 mc. ± 10 cps. For detailed specifications, write to *New London Instrument Company, P. O. Box 189, New London, Conn.*

BARRETT MOUNT

For use with 1.00" x .500" O.D. wave guide, the *Airtron* fixed-tuned barretter mount has been designed for microwave crystal mount-type barretters and contributes a maximum VSWR of 1.5 over an operating frequency range of 8500 to 9600 mc. In making power measurements, the mount and associated barretter are utilized in conjunction with suitable watt meter bridges.

Features include a choke filter which has been incorporated in the output connector to reduce microwave leakage



from the mount, and an impedance-matching diaphragm at the wave guide UG-39/U input connector to produce broadband characteristics. For further information, write to Dept. A., *Airtron, Inc., 1103 W. Elizabeth Ave., Linden N. J.*

BALANCED MODULATOR

Suitable not only for short pulses but for any wide-band modulation, the Type 1000-P7 balanced modulator has

a modulation frequency response flat from d.c. to 20 mc. The usable carrier frequency range extends from 60 to 2300 mc., and 100% amplitude modulation can be obtained throughout this carrier range. Double-sideband suppressed-carrier modulation and pulse modulation with 60-db carrier suppression between pulses are also possible

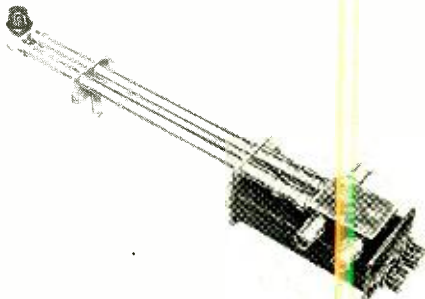

throughout the entire carrier frequency range.

Announced by the *General Radio Company*, 275 Massachusetts Ave., Cambridge 39, Mass., the Type 1000-P7 handles television video through the u.h.f.-TV band. Other applications include tests on microwave relay systems using multiplex pulse-code modulation, on omnirange and DME equipment, on telemetering circuits, and on high-resolution radar.

FREQUENCY PHASE COUNTER

An ultra-low frequency phase counter is now available from *Advance Electronics Co., Inc.*, 451 Highland Ave., Passaic, N. J., for 0.0001 to 1000 cps. Its outstanding features are (1) a revolutionary new gating circuit with interlocking arrangement offers dependable operation, (2) plug-in units increase the usefulness to three or four times, and (3) the lower limit of the frequency range can be extended to 0 cps with an external timing unit.

The instrument consists of three plug-in units—a decade counter and

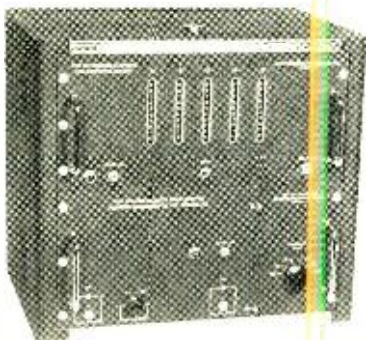

switching circuit, a timing unit, and a function unit. For measuring phase angle, the input sensitivity is 1 volt peak minimum and the input impedance is approximately 24,000 ohms shunted

with 30 μ fd. Accuracy is ± 1 count per 100,000, or $\pm 0.5^\circ$.

REFERENCE CAVITIES

The line of high-precision reference cavities which has been announced by *Bomac Laboratories, Inc.*, Salem Rd., Beverly, Mass., covers six different frequencies. Essentially fixed-frequency vacuum-sealed transmission-type tubes, these cavities are primarily for use as frequency-determining references and frequency stabilizers in radar beacon applications. Temperature stability from 0°C to 100°C is ± 0.3 mc.; from 0°C to -55°C , it is ± 1.0 mc. By cushioning each tube within the block, resonant frequency is held to ± 0.1 mc. under vibration and shock up to 50 g.

VACUUM TUBE ELECTROMETER

Designated as Model 210, the new *Keithley* vacuum tube electrometer is a line-operated d.c. voltmeter with an extremely high input impedance. Basic



specifications include an input greater than 10^{11} ohms, a grid current below 10^{-13} ampere, and drift within 10 mv. per hour. Five voltage ranges are provided: 0-0.8, 2, 8, 20 and 80 volts in either polarity.

This improved electrometer has output terminals for driving balanced or unbalanced recorders and recorder amplifiers, oscilloscopes, and galvanometers. Frequency response of the output amplifier is 0-5000 cps, making the Model 210 an ideal d.c. preamplifier wherever an ultra-high input impedance is needed. For full details, write to *Keithley Instruments*, 3868 Carnegie Ave., Cleveland 15, Ohio.

BROADBAND POWER METERS

Complete coverage over the frequency range of 20-10,000 mc. for average power levels of 20 microwatts to 5 watts is offered by the series of broadband power meters announced by *Bruno-New York Industries Corpora-*

tion, 460 West 34th St., New York 1, N. Y. Six models are available to cover the frequency and power ranges, each including a d.c. summation bridge and

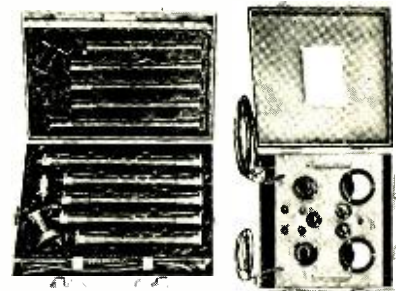

a complete kit of precision broadband r.f. components.

The instruments are direct-reading in average power, and are equally suited to either field or laboratory use for any application which requires the accurate measurement of r.f. or microwave power. Both pulse and c.w. power may be measured with a high degree of accuracy.

CAVITY OSCILLATOR

Design and production of a rocket tube cavity oscillator for microwave signal generation has been announced by *Amerac, Incorporated*, 116 Topsfield Rd., Wenham, Mass. A small-size coaxial-line cavity oscillator, employing a *Sylvania* u.h.f. planar triode, the #192A provides a highly stable r.f. signal source in both a c.w. and a pulse model. Features include a single knob control and fixed feedback.

The #192A is available at frequencies from 1000 to 4000 mc. with a tuning range of 400 mc. Peak pulse power is 200 watts at 2000 volts peak, and c.w.

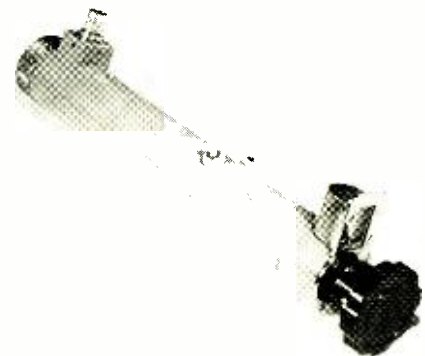

operation is 175 volts with an average output power of 100 mw. Tuning accuracy is $\pm .1\%$ when a regulated power supply is used.

DUAL PRESET COUNTER

For precision control of coil winding machines, automatic packaging,
(Continued on page 37)

COMMUNICATION

REVIEW

"TRAFFICMASTER"

Operating in the 25 to 50 mc. frequency range, the *Bendix* "Trafficmaster" consists of a separate transmitter, receiver, and power supply mounted in a single, rugged, compact housing. It is specifically designed for mobile two-way communications and may be used for fixed station, marine, aeronautical and other types of service. Easily portable, the unit can be mounted in relatively inaccessible locations.

The MRT-10 is available in six different models with 6 or 12 volts d.c. input in three frequency bands from *Bendix Radio*, division of *Bendix Aviation Corporation*, Baltimore 4, Md.

Features include specially designed heavy-duty high-efficiency vibrator power supplies for instantaneous full power operation, stacked selenium rectifiers to eliminate needless replacement of rectifier tubes, dual channel operation if desired, and strip construction of individual chassis to facilitate servicing and maintenance.

RADIO PROPAGATION RESEARCH

For many years, the Central Radio Propagation Laboratory (CRPL) of the National Bureau of Standards has been engaged in research directed towards the increased utilization of the available radio spectrum by almost every phase of industry, commerce, science

and the Armed Services. This research, concerned primarily with radio propagation, insures development of better systems, more accurate standards, and more reliable propagation forecasts.

Shown in the photograph are the microwave components of a refractometer used by CRPL to measure the refractive index of the lower atmosphere. During a measurement, these components are raised to the top of a 500-foot tower. Information on refractive index



is correlated with other data to assist in propagation predictions.

To provide even better service, NBS is establishing a new multimillion-dollar radio research laboratory in Boulder, Colorado. Dedication ceremonies for this laboratory, which will house the CRPL, will be held on September 8-11. It is expected that these new facilities will provide much additional information on the characteristics of radio energy under diverse conditions.

PYE OPENS U. S. OFFICE

Pye Limited, Cambridge, England, has announced the opening of an office at 200 Fifth Avenue, New York 10, N.Y., and the appointment of William M. Cagney as regional supervisor for the activities of the *Pye* group of companies in the United States.

The *Pye* organization, of which *Pye Limited* is the parent company, consists of many divisions devoted to the design and manufacture of high quality TV studio and transmission equipment, scientific instruments, radio and television receivers, telecommunications equipment, electronic components, sound amplifying equipment and electric appliances.

Mr. Cagney, formerly sales manager and manager of the Sales Engineering Department of *Link Radio Corporation*, has specialized in the design and sale of many large mobile and point-to-point radio systems.

BATTERY CHARGER

It is no longer necessary for two-way radio-equipped vehicles to keep engines idling while off-the-road work is being done, according to *D. W. Onan & Sons Inc.* Batteries can now be charged right in the field with a new regulated battery charger designed primarily for utility work trucks equipped

CIVIL DEFENSE COMMUNICATIONS SYSTEM

THE CIVIL DEFENSE communications system in operation in Los Angeles, Calif., is believed to be the first and largest city-owned system of its type in the nation. It is built around four master control stations; three of these are contained in trailer trucks, which can be rapidly moved to strategic sites in the Los Angeles area, while the fourth is a permanent installation adjacent to the Coliseum. Each master control station is equipped to transmit and receive messages from any part of a far-flung communications network.

In an emergency, this system will coordinate activities of thousands of municipal and private vehicles now equipped with two-way radio. Tied together by the radio system are the city's commissioners and executives; municipal departments such as public works, fire, police, health, transportation, water and power, and harbor; private

companies operating radio-equipped vehicles such as taxicabs and electric utilities; the Red Cross; and a vast network of volunteer amateur radio operators. Designed to be used in "natural disasters" such as fire, tornado, earthquake or flood, as well as during defense emergencies, the system has already proved effective in communication with city trucks and vehicles at work maintaining and repairing segments of Los Angeles' vast network of transportation facilities.

Major components of the Los Angeles communication system, in addition to the four master stations, include 150 radio-equipped automobiles and trucks, two-way radios, 100 walkie-talkie type units, and 60 medium-power transmitting and receiving stations installed at fixed locations throughout the city. A microwave radio transmission system, installed between City Hall and Mt. Lee in the Hollywood Hills, allows the Commissioner of Public Works to maintain radio contact with his forces via high-power transmitting and receiving equipment installed on Mt. Lee. The radio station on Mt. Lee also serves as a contact with the State Civil Defense control system.

The necessity for a well-planned communications network, nerve center of every Civil Defense operation, was originally envisioned by Colonel K. C. Bean, manager of the city's Department of Public Utilities, in 1951. Realization of the plan has been brought about by Colonel P. B. McCarthy, Senior Deputy Director, Civil Defense, and the *General Electric Company* communication advisory service, working cooperatively under the direction of T. M. Chubb, Colonel Bean's successor. *General Electric* radio equipment is used throughout the system.

Close-up of operator at controls of the master console in the truck trailer communications center.



with two-way radio and other accessories requiring a 6-volt d.c. power supply.

Devised for use in the field with an Onan a.c. electric generating plant, this compact unit keeps batteries charged at a minimum of cost. It draws its a.c. input power from the auxiliary electric plant, takes over the d.c. load, charges the 6-volt storage battery, and provides up to 25 amperes for powering the two-way radio equipment. For complete information, ask for Form A-308, available from *D. W. Onan & Sons Inc.*, Minneapolis, Minn.

"FLYWEIGHT" POWER TRIODE

Intended for use in airborne communications, the RCA-6383 is an eight-ounce "flyweight" power triode with high power output at ultrahigh frequencies. Announced by the Tube Division of *Radio Corporation of America*, Harrison, N. J., it will help make possible new weight-and-space saving radio transmitters with high power capabilities.

The RCA-6383 has a maximum plate dissipation of 600 watts and can be operated with full plate voltage and plate input at frequencies up to 2000 mc. It is designed for both liquid- and forced-air cooling to provide maximum efficiency at high altitudes.

SELECTIVE CALLING TELEMETERING

"Metameter" telemeters manufactured by *The Bristol Company*, Waterbury 20, Conn.,—combined with an *AT&T* Sotus unit and dialing selector—are being used by the *Tennessee Gas Transmission Company* to control pressure, flow, and metering at delivery points spread over a 150-mile range in the mountains of West Virginia. The entire system is controlled by a field dispatcher from a central station at Broad Run, W. Va.

There are six delivery points which include both two-meter and three-meter tube meter and regulating stations. Wide demand variations sometimes make it necessary for *TGT* to transfer as much as 3500 million cubic feet of gas per hour from one point to another at any hour of the day or night.

AVIATION EQUIPMENT

Various instruments for aviation communications use are discussed and illustrated in the *Collins "Signal,"* Vol. 3, No. 4, published by *Collins Radio Company*, Cedar Rapids, Iowa. The equipment covered includes navigation receivers, a flight director system, automatic pilot system, magnetic compass system, ground VOR system: h.f. and v.h.f. equipment, antennas, ground-to-air equipment, and a remote control system.

NOW...

A SUPER LINE OF ACCESSORIES THAT SURPASS ACCEPTED STANDARDS—for STUDIO, MOBILE and MICRO-RELAY EQUIPMENT

Famous BALANCED TV Head supporting a TV camera. Both are mounted on one of our all-metal tripods, which in turn is mounted on a *Ceco Spider Dolly*. Here is a "team" outstanding for versatility and maneuverability in studio or on location.



New Model C BALANCED TV Head provides correct center of gravity in a FLASH—without groping. No matter what focal length lens is used on the turret, the camera may be balanced by the positioning handle without loosening the camera tie-down screw. Something every cameraman has always desired.



ALL-METAL TRIPOD



Has fixed shoe, also fixed spurs. Rubber pads prevent slipping. These may be flipped out of position, leaving the spur exposed. One lock knob for setting up and breaking down tripod legs, which operate in unison.

ROOFTOP CLAMPS



Secures tripod of camera or beam reflector to car top. Made of bronze and brass, with ball-type, yoke-swivel construction. A lot depends on roof clamps—that's why these are made with EXTRA care.

Similar to BALANCED TV head, this new Professional Junior Spring head is ideal for Vidicon cameras weighing up to 25 lbs. Spring head till assures camera will return to neutral position when lever is in unlocked position... a wonderful safety factor.



MINI-PRO

New lightweight all-metal MINI-PRO Tripod fulfills a tremendous need—especially for Vidicon cameras weighing up to 8 lbs. Low height measures 33" and maximum height 57". Reversible spur and rubber cushions. Maximum leg spread 35°.



NEW PORTABLE 3-WHEEL COLLAPSIBLE DOLLY



Dolly folds to fit into carrying case—18"x12"x36". Weighs only 60 lbs. Has wheel in rear for steering, which may be locked for straight dollying.

DOLLY COLLAPSED

FRANK C. ZUCKER

CAMERA EQUIPMENT CO.

DEPT. R-9-13 1600 BROADWAY • NEW YORK CITY



got enough EARS?

BE ON THE CONSTANT ALERT

All Departments Can Now Listen to Every Vital Message

- Nation's most complete line of monitor receivers.
- Crystal controlled or tunable for any VHF FM communication system.
- Mobile or stationary receivers.
- Prices to meet any budget.
- Certified for civil defense use.

MONITORADIO for a thoroughly coordinated 2-way communication system.

Now every member of every department can have radio communication for as little as \$49.95

Write today for further information.

MONITORADIO RADIO APPARATUS CORPORATION
55 North Jersey St., Indianapolis, Ind. Phone: ATLantic 1624

NEW TUBES

COMPACT TV TUBE

Raytheon Manufacturing Company has announced a 17" monochrome picture tube—Type 17AVP4—which is 3½" shorter in over-all length and approximately four pounds lighter than present 17" models. An electrostatic-focus and magnetic-deflection tube, it incorporates a new 90° deflection bulb

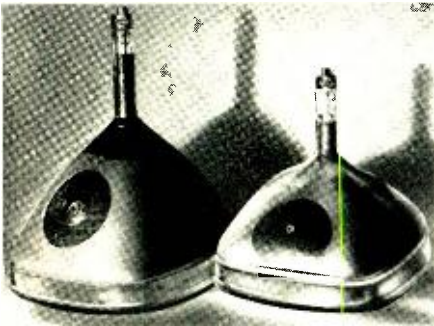

with a 1"-shorter neck length, and thus achieves maximum compactness with conventional viewing area. In the photograph, the 17AVP4 (at right) is compared in size with a standard 17" tube.

Data on the 17AVP4 is available from Technical Information Service, *Raytheon Manufacturing Company*, 55 Chapel St., Newton 58, Mass.

HIGH SPEED COUNTING TUBE

For use in fast registers and counters, the Model GC-10D "Dekatron" is a new cold-cathode counting tube with a maximum input frequency of 20,000 counts per second. The latest addition to the "Dekatron" line, it has a scale of 10; the count may be determined by noting the position of the glow on any one of the ten cathodes radially spaced around an axially positioned anode. Resetting is accomplished by a simple push button.

"Dekatron" tubes are manufactured in Great Britain by *Ericsson Telephones Ltd.* and are available exclusively in the United States and Canada from *Atomic Instrument Company*. Further information on the Model GC-10D and circuits employing this tube may be obtained from *Atomic Instrument Co.*, Cambridge, Mass.

MINIATURE TWIN TRIODE

The high perveance and increased plate current capacity of the new *G-E* miniature twin triode, Type GL-6463, permit the design of electronic computers which will operate faster than

many now in use. Developed primarily for amplifier or counter service in digital computers, its plate dissipation of 4 watts per plate and 7 watts total assures long and dependable operation.

Like its companion computer types GL-5965 and GL-5844, the new tube incorporates a special heater-cathode construction for dependability under frequent "on-off" switching conditions; it will maintain its emission capabilities after long periods of cutoff operation. Additional information on the GL-6463 is available from the Tube Department of the *General Electric Company*, Schenectady 5, N. Y.

ALUMINIZED PICTURE TUBES

With the production of new 10", 12" and 20" aluminized TV picture tubes, *Sheldon Electric Company* announces the availability of a complete aluminized *C-R* tube line in all sizes from 10" to 27" with tilted electron guns. The 20" models are said to be the only aluminized tubes of that size now available to television set manufacturers or distributors.

Further information and specifications may be obtained from *Sheldon Electric Company*, 69 Coit St., Irvington 11, N. J.

CLASS B IGNITRON

Designed especially for resistance welding equipment control and similar a.c. control applications, the NL-1051 is a new Size B ignitron with provisions for thermostatic mounting. Introduced by *National Electronics, Inc.*, Geneva, Ill., it utilizes a protection system that depends entirely upon tube temperature, and it may be used to replace any Size B ignitron (5551).

The NL-1051 is equally efficient when employed with cooling systems using raw water or with recirculating systems. In the case of recirculating systems where the temperature of the water is high, protection is provided without danger of unnecessary shutdowns. It is also particularly effective



in plants with limited or fluctuating water supply. A substantial water saving can result from the reduced water flow requirements of a particular welding job, often as much as 80% or more.

XENON THYRATRON

An improved version of the C3J/A xenon thyratron has been announced by *Taylor Tubes, Inc.*, in which grids constructed with the exclusive *Taylor* gold flow process are assured of sharp-cutoff characteristics throughout tube life. Other construction features include: an arc-resisting high-emission cathode, a nickel-brazed anode assembly, and automatic gettering action.

The new 5684/C3J/A tube has a 3-ampere average anode current and a low average arc drop of 8 volts. Ambient temperature limits are -55 to +85°C. Warm-up time is 30 seconds, and deionization time less than 500 μsec. Life expectancy is over 2000 hours when the tube is operated within ratings. For additional information, write to *Taylor Tubes, Inc.*, 2312 W. Wabansia Ave., Chicago 47, Ill.

MERCURY VAPOR RECTIFIER

To meet the demand for a comparatively inexpensive, long-life rectifier for relatively high voltage and current operation, *Amperex Electronic Corporation* has developed a new mercury vapor rectifier tube. Designated as the Type 6508, this tube is designed for many industrial and communications applications where standard tubes have not been used because of initial and replacement costs.



Type 6508 has a peak inverse voltage rating of 21 kv. and a voltage drop of 14 volts. The cathode is directly heated and oxide coated.

For additional information, write to the Engineering Department, *Amperex Electronic Corporation*, 230 Duffy Ave., Hicksville, L. I., N.Y.

RCA TUBES

Among the various tubes which have recently been announced by the Tube Department of the *Radio Corporation of America*, Harrison, N. J., are: the RCA-3A2, a TV pulsed rectifier; RCA-6AS8, a diode—sharp-cutoff pentode for diversified receiver applications;

RCA-6BC4, a medium- μ triode for u.h.f.-TV tuners; and the RCA-6BD4-A, a sharp-cutoff beam triode.

Pulsed Rectifier

Designed for the scanning systems of color TV receivers, the 3A2 (right) is

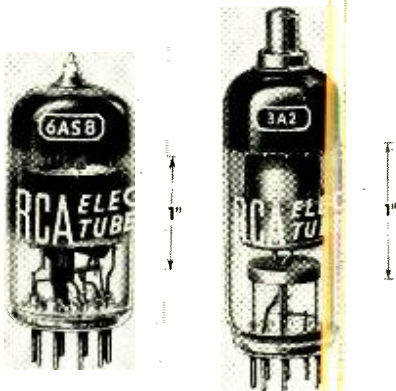

a half-wave vacuum rectifier of the 9-pin miniature type utilizing an indirectly heated cathode. It is rated to withstand a maximum peak inverse plate voltage of 18,000 volts and can supply a maximum peak plate current of 80 ma. and a maximum average plate current of 1.5 ma.

Diode—Pentode

Containing a high-perveance diode and a sharp-cutoff pentode in one envelope, the 6AS8 (left) is a general-purpose multiunit tube of the 9-pin miniature type. The pentode unit with its high transconductance may be used as an i.f. amplifier, video amplifier, and a.g.c. amplifier, while the diode is especially useful as a picture detector or d.c. restorer.

U.H.F. Triode

The 6BC4 is a short medium- μ triode of the 9-pin miniature type for use as a cathode-driven r.f. amplifier covering the frequency range from 470 to 890 mc. Having a transconductance of 10,000 micromhos, the 6BC4 facilitates circuit design to provide high gain and reduced equivalent noise resistance. In addition, there is low lead inductance and resistance, and good isolation within the tube between the load circuit and the input circuit.

Beam Triode

A low-current beam triode, the 6BD4-A is designed specifically for voltage regulation of high-voltage, low-current d.c. power supplies, such as are used for picture tubes in color TV receivers. It supersedes the 6B4 and is unilaterally interchangeable with it. The 6BD4-A has a maximum d.c. plate-voltage rating of 27,000 volts, compared to 20,000 volts for the 6B4.

NEW Carter SLIDE CHART

SHOWS DYNAMOTOR EFFICIENCY

25¢ at a Glance!

AT YOUR RADIO PARTS DISTRIBUTOR OR ELECTRONIC EQUIPMENT SUPPLIER

Now it's easy to compare Dynamotor performance efficiency under actual operating conditions. Nameplate information plus this simple slide chart enables you to read instantly the efficiency percentage right from the Calculator scale. Reverse side gives other useful information. Handy 3" x 6" pocket size, color printed on sturdy laminated stock, varnished to resist soil. For sale by radio parts distributors and electronic equipment suppliers, or 25c postpaid.

WRITE for FREE DYNAMOTOR CATALOG

Carter Motor Co.

2641 N. MAPLEWOOD AVE. CHICAGO 47

World's largest Exclusive Manufacturers of mobile radio rotary power Supplies.

Precision PAPER TUBES

2000 SIZES in any shape ID or OD

Whatever your specific needs, depend on PRECISION PAPER TUBES to meet all requirements. Spirally wound under pressure, PRECISION PAPER TUBES are subjected to rigid tolerance control to insure strict adherence to specifications and provide maximum winding space. PRECISION PAPER TUBES possess 15 to 20% greater strength, yet are light in weight.

Made from the finest dielectric kraft or fish paper, phenol impregnated, acetate or combinations, PRECISION PAPER TUBES afford high insulation, heat dissipation and moisture resistance. Available in any size, shape, I.D., or O.D.—any quantity.

Write today for Arbor List of over 2000 sizes. . . . Send specifications for free sample.

PRECISION PAPER TUBE CO.

2063 WEST CHARLESTON STREET • CHICAGO 47 • ILLINOIS

Plant No. 2: 79 Chapel St., Hartford, Conn. — Also Mfrs. of PRECISION Coil Bobbins

NEW LITERATURE

RCA TUBE BROCHURES

Three new brochures on RCA tubes have been published by the Tube Department of *Radio Corporation of America*, Harrison, N. J. One of these, entitled "Getting the Most Out of Your Image Orthicon," is a reprint of a talk given by Ralph E. Johnson, broadcast tube specialist, which is designed to give the personnel of new TV stations as much information as possible on the operation of the RCA image orthicon.

Form No. CRPS-102-A lists the various types of RCA phototubes, cathode-ray and special tubes, with characteristics, ratings and dimensional outlines, while Form No. PG-101-A deals with

vacuum power tubes, glow-discharge (cold-cathode) tubes, rectifiers, thyratrons and ignitrons in a similar manner. The latter two booklets are available for 15 cents each.

"ROTOROIDS"

Information on a new series of "Rotoroids"—variable toroidal inductors—is presented in a technical bulletin entitled "Rotoroid," which may be obtained from Dept. D, *Burnell & Company, Inc.*, 45 Warburton Ave., Yonkers, N. Y. These hermetically sealed units provide a continuous three-to-one maximum-to-minimum inductance range with 180° shaft rotation, employ a

NBS ATOMIC CESIUM CLOCK

LIMITATIONS of the present standard of time, the mean solar day, have resulted in a continuing search by the National Bureau of Standards for new methods to determine time and frequency. The original NBS atomic clock, developed during this investigation, utilized the absorption characteristics of ammonia to provide a control element in a servo loop containing a precision oscillator. Success of the original clock has now led to a further development in which cesium atoms are used.

The new cesium clock is shown in the photograph. A beam of cesium

atoms is discharged and made to move down the cylinder from left to right. The characteristics of these atoms when they pass through an electromagnetic field set up by microwave energy are such that they vary from a straight-line path. Suitable instruments can be arranged to detect this variation and feed a voltage back into the microwave generator so as to make the generator correct itself and thereby produce the correct frequency. With this development, accuracies of better than one part in ten billion can be obtained.



The NBS atomic clock which utilizes a beam of cesium atoms.

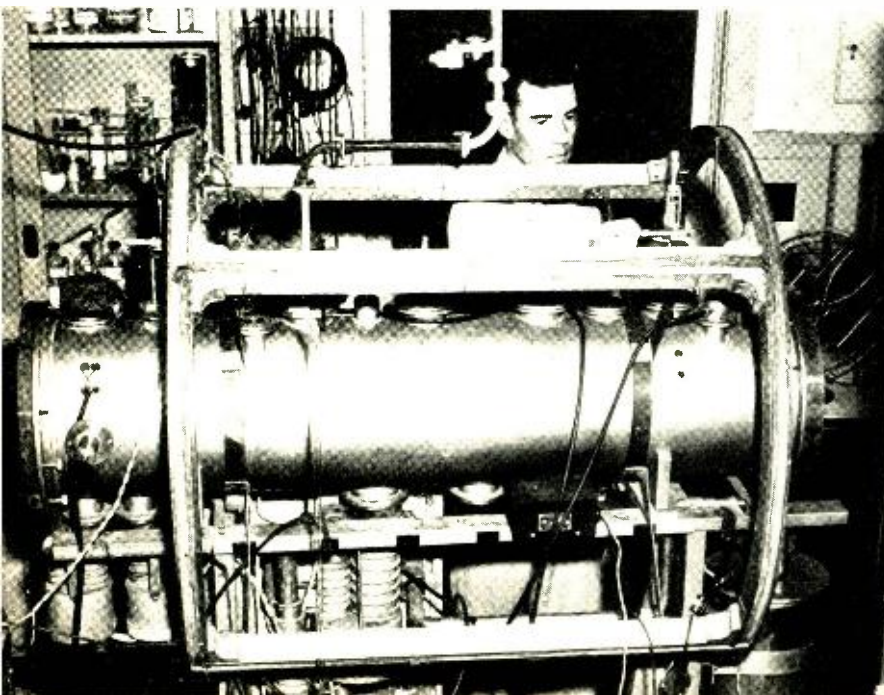

permeability tuning method, and require no d.c. saturating current. The choice of nominal inductance is virtually unlimited.

MINIATURIZATION TECHNIQUES

National Bureau of Standards Circular 545, entitled "Subminiaturization Techniques for Low-Frequency Receivers" and containing 64 pages, 44 figures, and two tables, is available from the Government Printing Office, Washington 25, D. C., for 50 cents a copy.

This publication covers the second phase of a continuing program for the development of miniaturization techniques applicable to airborne military electronic equipment. The work was carried out by the General Miniaturization Group of the NBS Engineering Electronic Section, under support of the Bureau of Aeronautics, Department of the Navy.

VARIABLE INDUCTORS

Characteristic curves for typical "VARI-L" electrically variable inductor models will be provided free of charge by the *Vari-L Company, Inc.*, P. O. Box 1433, Stamford, Conn., to all qualified technical personnel who request it. The "VARI-L" inductor is a high frequency saturable core reactor designed for controlling, as a function of a d.c. or a.c. current, the resonant frequency of a tuned circuit. Its high sweep rate capabilities and wide range make it a logical choice for use in place of reactance tubes or mechanical modulators.

ENVIRONMENTAL TESTING

Environmental testing is the subject of a four-page folder which has been published by the *New York Testing Laboratories, Inc.* Tests described include those for vibration, shock, acceleration, high and low temperature and temperature shock, humidity, high altitude and explosion, salt spray, and sand and dust.

Some of the environmental equipment used in making these tests is also described and illustrated in the folder, and the more common types of equipment which may be subjected to environmental testing are listed. A copy may be secured by writing to *New York Testing Laboratories, Inc.*, Dept. REE, 47 West St., New York, N. Y.

MICROWAVE DUPLEXERS

Airtron, Inc. has published a six-page bulletin entitled "Branching and Balanced Duplexers" which covers design theory and applications of microwave duplexers. Listed as Technical Bulletin T-2200, it offers an analysis of the operational and electrical characteristics

(Continued on page 39)

CALENDAR of Coming Events

AUGUST 25-27—WESCON (Western Electronic Show and Convention), Pan-Pacific Auditorium and Ambassador Hotel, Los Angeles, Calif.

SEPTEMBER 8-11—Symposium on Radio Propagation and Standards, Boulder (Colorado) Laboratories of the National Bureau of Standards.

SEPTEMBER 15-17—Symposium on Information Theory, Massachusetts Institute of Technology, Cambridge, Mass.

SEPTEMBER 17-18—Conference on Communications, sponsored by Cedar Rapids Section, IRE, Cedar Rapids, Iowa.

SEPTEMBER 29-30—Symposium on Industrial Electronics, Mellon Institute, Pittsburgh, Pa.

SEPT. 30-OCT. 1—Fifth Annual Meeting of the IRE Professional Group on Vehicular Communications, Rice Hotel, Houston, Texas.

SEPT. 30-OCT. 2—International Light and Sound Exposition, Palmer House, Chicago, Ill.

OCTOBER 4-6—National Electronics Conference, Sherman Hotel, Chicago, Ill.

OCTOBER 6-7—IRE Professional Group on Nuclear Science Annual Conference, Sherman Hotel, Chicago, Ill.

OCTOBER 11-15—AIEE Fall General Meeting, Morrison Hotel, Chicago, Ill.

OCTOBER 13-15—Symposium on Marine Communication and Navigation, Hotel Somerset, Boston, Mass.

OCTOBER 13-17—Annual Convention, Audio Engineering Society, Hotel New Yorker, New York, N. Y.

OCTOBER 14-17—Audio Fair, Hotel New Yorker, New York, N. Y.

OCTOBER 18-20—Radio Fall Meeting, Hotel Syracuse, Syracuse, N. Y.

OCTOBER 26-28—Second National Conference on Tube Techniques, Western Union Auditorium, New York, N. Y.

NOVEMBER 4-5—East Coast Conference on Airborne and Navigational Electronics, Sheraton-Belvedere Hotel, Baltimore, Md.

NOVEMBER 8-10—Microwave Symposium, Engineering Societies Auditorium, New York, N. Y.

NOVEMBER 10-11—IRE-AIEE Conference on Electronic Instrumentation and Nuclonics in Medicine, Morrison Hotel, Chicago, Ill.

NOVEMBER 12-13—IRE Quality Control Symposium, Statler Hotel, New York, N. Y.

NOVEMBER 18-19—Sixth Annual Electronics Conference, sponsored by the Kansas City Section, IRE, Hotel President, Kansas City, Mo.

NOVEMBER 18-19—Symposium on Fluctuation Phenomena in Microwave Sources, Western Union Auditorium, New York, N. Y.

NOVEMBER 21-22—Automation Show, Waldorf-Astoria Hotel, New York, N. Y.

NOVEMBER 29-DECEMBER 2—International Automation Exposition, 244th Regiment Armory, New York, N. Y.

Microwave Link

(Continued from page 9)

from the ground on a single wooden pole, are beamed directly at Rocky Point.

System Advantages

The entire microwave link fits neatly into RCA's over-all communications operations. Designed for 600-ohm impedance, the CW-20 equipment matches perfectly the wide- and narrow-band channel requirements of the company's multiplex gear.

From an economic standpoint, the

savings which can result from the high capacity operation of a microwave system can pay for an entire link in a comparatively short time. From a reliability standpoint, microwave propagation conditions are usually at their best during ice and wind storms which sometimes snap pole lines. Microwave beams also avoid man-made hazards, such as an occasional automobile which collides with a telephone pole. During an emergency, when communications are most urgent, a microwave system avoids the use of miles of vulnerable wire line or underground cables.

An Announcement

of the Utmost Importance to Engineers
Doing Research and Design Work in
the Entire Audio Frequency Range.

BURNELL and CO., Inc.

is proud to announce the
development of an
entirely new product—

ROTOROID®

a Variable Toroidal Inductor (patent applied for)

ROTOROID will prove to be a valuable aid in the solution of many engineering problems—in research and

design—and opens new possibilities for production which were previously impractical or impossible.



ROTOROID •... is a continuously variable, stepless toroidal inductor which can provide a 3:1 range of maximum to minimum inductance in 180° rotation of a shaft.

- ... employs no mechanical resistance contacts and is therefore free of noise and wear.
- ... requires no DC saturating currents and thereby eliminates the need for circuitry.
- ... is applicable over the entire audio range (from approximately 300 cps). ROTOROID is not limited to any stock value of nominal inductance. It is available in any value of inductance now available in regular toroids.
- ... is hermetically sealed and is vibration and shock-proof, can be chassis or panel mounted.

Write Department D for further information.

BURNELL & CO., Inc.

Yonkers 2, New York
PACIFIC DIVISION: 720 Mission Street
South Pasadena, California



FIRST IN TOROIDS AND RELATED NETWORKS

An outstanding feature of ROTOROID is that, at maximum inductance, it provides the full Q of the toroid it contains. Thus, the user is at once able to take advantage of the high Q characteristics of toroids while at the same time having available a variable inductor not previously available in a toroid.

Application: Virtually unlimited.
Just a few of the many possible uses of ROTOROID are:

- Tunable Audio Oscillators
- Variable Z Devices
- Servo Systems
- Telemetry
- Adjustable Selective Networks
- Variable Phase Shift Networks
- Variable Filters
- Electro-Mechanical Control Systems

Auricon Hollywood

16mm SOUND-ON-FILM EQUIPMENT FOR TELEVISION NEWSREELS, TV FILM INSERTS AND KINESCOPE RECORDINGS... SOLD WITH A 30-DAY MONEY-BACK GUARANTEE. YOU MUST BE SATISFIED!

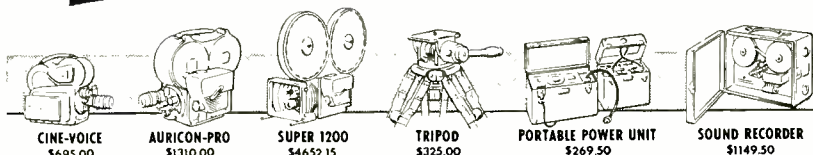

CINE-VOICE
\$695.00

AURICON-PRO
\$1310.00

SUPER 1200
\$4652.15

TRIPOD
\$325.00

PORTABLE POWER UNIT
\$269.50

SOUND RECORDER
\$1149.50

WRITE FOR FREE
ILLUSTRATED
INFORMATION

BERNDT-BACH, Inc.
6928 Romaine St., Hollywood 38, Calif.

MANUFACTURERS OF SOUND-ON-FILM RECORDING EQUIPMENT SINCE 1931

HARVEY

STOCKS COMPLETE LINE OF

KRECO

Custom-Built Antennas

When ordering, please specify exact frequency. Each antenna is precisely cut to your exact integral frequency to assure optimum gain performance.

CO-AXIAL

A vertical co-axial radiator machined entirely of brass. Matches 72-ohm coax lines. Low angle radiation.

- CO-150**—for frequencies from 120 to 170 mc **\$19.95**
CO-50 —for frequencies from 50 to 120 mc **24.95**
CO-30 —for frequencies from 30 to 50 mc **29.95**



GROUND PLANE

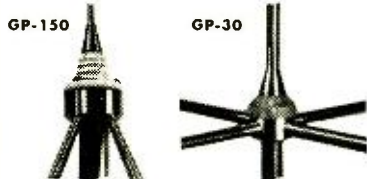

A vertical ground plane radiator, machined entirely of brass (GP-30 with aluminum elements). Matches 52 ohm coax lines (GP-30 matches 72-ohm with quarter-wave feedline).

- GP-150**—for frequencies from 120 to 170 mc **\$19.95**
GP-30 —for frequencies from 30 to 54 mc **29.95**

STACKED COAXIAL

A vertical 4-element, coaxial array, machined entirely of brass. Matches 72-ohm cables. Very low angle of radiation. Provides extraordinary gain over regular coax: up to 18 db gain for maximum radiation.

- SC-150**—for frequencies from 120 to 170 mc **\$49.50**

UHF BROADBAND

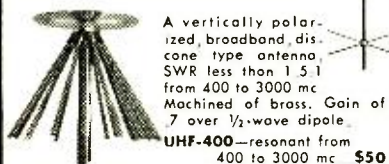

A vertically polarized, broadband, disc cone type antenna. SWR less than 1.5:1 from 400 to 3000 mc. Machined of brass. Gain of 7 over 1/2-wave dipole.

- UHF-400**—resonant from 400 to 3000 mc **\$50**

Note: all Krecos are threaded to fit standard 3/4" pipe and are designed so that feedline is enclosed inside pipe mast (feedline and mast not supplied).

Complete price list of commercial, industrial and other ham-band antennas on request.

Anywhere in the world —

order by mail direct from Harvey. Enclose estimated shipping charge. Excess will be refunded.

NOTE: Prices Net, F.O.B., N.Y.C. Subject to change without notice.



Harvey
RADIO COMPANY, INC.

103 W. 43rd St., N. Y. 36, N. Y. • JU 2-1500

Personals



DR. I. EDWARD BLOCK, mathematical specialist who co-founded the Society for Industrial and Applied Mathematics two years ago, has now been appointed computer consultant by *Burroughs Corporation*, Electronic Instruments Division, Philadelphia, Pa. Acting as a technical liaison to customers who rent the services of the *Burroughs* unitized digital computer, Dr. Block will analyze their complex mathematical problems in design and data correlation.



JAMES BURGESS has been appointed head of the newly formed product engineering department at *Eitel-McCullough, Inc.*, San Bruno, Calif., manufacturers of *Eimac* electron power tubes. In this position, his duties will include directing plant activity in design testing, quality control and special engineering assignments arising from plant or customer requirements. Mr. Burgess has been with the *Eimac* research laboratories since 1949.



NORMAN CAPLAN is the new manager of commercial engineering at the *Bendix Radio Communications Division* of *Bendix Aviation Corporation*, Baltimore, Md. Chief engineer of communications and navigation engineering since 1952, he will now be responsible for commercial product development in the aviation, automobile and mobile radio fields. Mr. Caplan received the Legion of Merit for navigation and radar work with the Air Force in World War II.



FRANK W. EDMONDS was named president of the recently formed *Burnell and Company, Pacific Division*, at South Pasadena, Calif., a wholly owned subsidiary of *Burnell and Company, Inc.*, Yonkers, N. Y., designers and manufacturers of toroidal coils. Having wide experience in the electronics industry, Mr. Edmonds has been associated with the *Langevin Mfg. Corp.*, *Radio Development and Research Corp.*, and *Federal Telephone and Radio Corp.*



DR. RODOLFO M. SORIA, who was formerly head of the Development Division of the *American Phenolic Corporation*, Chicago, Ill., has now been appointed director of engineering; he has been with *Amphenol* since 1946. Dr. Soria received his Ph. D. from the Illinois Institute of Technology. Prominent in the affairs of the Institute of Radio Engineers, he is the 1954 president of the National Electronics Conference.



C. L. (BOB) WHITE, as chief liaison engineer for *The Hammarlund Manufacturing Co., Inc.*, New York, N. Y. will coordinate engineering and sales activities relating to industrial applications of telemetering and remote control to petroleum refineries, pipelines, railroads and public utilities. Mr. White comes to *Hammarlund* from *R. B. Barnhill Associates* of Baltimore; he was previously associated with the *Brown Instrument Company*.

TECHNICAL BOOKS

"ELECTRONICS" by George F. Corcoran and Henry W. Price, Department of Electrical Engineering, University of Maryland. Published by *John Wiley & Sons, Inc.*, 440 Fourth Ave., New York 16, N. Y. 459 pages. \$7.00.

Intended as a first course in electronics, this book attempts to strike the correct balance between electro-tube and transistor physics on the one hand and the associated circuitry on the other. Although emphasis has been placed upon the circuitry aspect of the subject, the basic physical principles have been treated thoroughly at a level that can be readily understood.

After a brief introduction and a discussion of mobile charges, the text material proceeds from the elementary principles of vacuum-diode operation to an up-to-date discussion of feedback circuits, germanium diodes, transistors and oscillators. The equivalent plate circuit theorem is emphasized, and the concept of return voltage ratio is presented as an aid to understanding feedback circuits and oscillators—Nyquist plots of return voltage being employed as the criterion for stability of active electrical networks. Some 300 well-graded practice problems are included.

"SOFT MAGNETIC MATERIALS FOR TELECOMMUNICATIONS" edited by C. E. Richards and A. C. Lynch, Post Office Engineering Research Station. Published by *Interscience Publishers, Inc.*, 250 Fifth Ave., New York 1, N. Y. 346 pages. \$9.00.

The origin of this book was an informal conference on "soft magnetic materials whose properties are of use or significance for telecommunications" which was held at the Post Office Engineering Research Station, Dolis Hill, England, in April, 1952. It was compiled as a result of the general interest which the papers presented at this symposium aroused and because of the expressed desire of many electrical engineers and physicists to have them all in the form of a permanent record.

Slightly shortened versions of the 35 scientific papers appear here, together with some of the discussions which they evoked. These papers comprise an up-to-date account of the many important facets of magnetic experiment and theory, which concern high initial permeability and low coercivity, hysteresis losses, magnetic viscosity, the properties of ferromagnetic powders, the production and properties of ferrites, and many others. Both a subject and an author's index are included.

Wave Guide Adapters

(Continued from page 16)

A typical adapter application is illustrated in Fig. 1. At present, the most readily available and least expensive complete microwave test setup is in the so-called X band (8000 to 12,000 mc.), utilizing 1" x 1/2" rectangular wave guide. In Fig. 1, an X-band setup is being used to test water loads and dummy loads for energy absorption capabilities and standing wave ratios on S-band (3000-mc.) or lower frequencies as far down as the u.h.f. TV band (500 mc. or less). This can be done with the same single X-band test setup by merely inserting a tapered adapter or combination of adapters to mate the respective wave guide dimensions. As illustrated, from left to right, the units in the test setup perform as follows:

1. Micrometer-controlled klystron tube generates the required frequency in the 8000-12,000 mc. band. Power supply is at the rear. (This tube and power supply can be dispensed with by inverting an X-to-S band adapter and extracting the high frequency component of an S-band radar as an alternative energy source.)
2. Wave guide tuner resonates the tube for maximum output as indicated on the standing wave indicator in center.
3. Cavity wavemeter with micrometer head determines the frequency.
4. Slotted line or standing wave detector with a traveling probe extracts some energy from the slotted wave guide and passes it through a crystal rectifier to the standing wave indicator.
5. Appropriate size adapter provides transition from the 1" x 1/2" wave guide size of the test equipment to the wave guide size under evaluation.

Measurements made with the setup of Fig. 1 show that such a combination can have a VSWR of 1.03 or less.

Most adapters have the same taper angle. The greater the frequency transition, the longer is the taper or overall adapter length. The more gradual the transition (smaller the taper angle), the more efficient is the unit. To derive taper length or size for any input and output dimension/wavelength/frequency, a pyramid may be laid out—holding the same selected angle—and cut off at the required dimensional points, as shown in Fig. 4.

Adapters can be a boon to all organizations and individuals working with u.h.f. television microwave relay equipment, radar, microwave spectroscopy, etc. For every microwave frequency there is an optimum size for wave guide components which otherwise would require duplicate apparatus scaled up or down in size.

Completely New

666

VARIABLE D*
CARDIOID
DYNAMIC
for TV and BC



OUTPERFORMS ALL OTHERS

Combines ruggedness of single dynamic element with new acoustic principle. Eliminates pick-up of ambient noise, unwanted reverberation and equipment rumble. Uniformly smooth response 30-15,000 cps, laboratory controlled. Highest front-to-back discrimination. Virtually no proximity effect. Output —57 db. E-V Acoustalloy diaphragm. Blast filter. Detachable clamp-on swivel stand coupler. Weighs only 11 oz. 7 1/2" x 1 1/2". TV gray. 20' cable. 50 ohms. Readily changed to 150 or 250 ohms.

Model 666 Microphone. List \$245

Model 366 Boom Mount. List \$40

Model 300 Stand Coupler. List \$10

Model 420 Desk Stand. List \$20

Normal Trade Discount Applies

*E-V Pat. Pend.

Write for Data Sheet No. 39

Electro-Voice

BUCHANAN, MICHIGAN

NEWS BRIEFS

REBUILDING GIANT COMPUTER

The three-year-old giant digital laboratory computer at *Burroughs Corporation*, Philadelphia, Pa., is undergoing a complete overhauling to increase its memory capacity more than sixfold, improve its system of internal logic, and increase its speed of computation. It is being rebuilt as a brand-new computer in the ground-floor showase window of the Electronic Instruments Division headquarters, and will then be given the name of UDEC II (unitized digital electronic computer).

In the rebuilding of UDEC II, *Burroughs* will use 650 electronic chassis containing a total of close to 4000 vacuum tubes. "Building blocks" or pulse chassis, each of which will perform a single function in the lengthy sequence



of operations necessary to solve involved problems, will be stacked in the vertical racks shown in the photograph.

LIFE RECORD FOR TV TUBE

At Station KRON-TV, San Francisco, a new life record has been established for an RCA-8D21 transmitting electron tube. First entering active service in September, 1951, in the sound portion of the station's TT-5A television transmitter, it was used as a driver for KRON-TV's TT-25AL transmitter from February, 1953, until its recent retirement, by which time it had logged an unprecedented 15,646 hours of full-power operation.

A water-and-forced-air-cooled push-pull tetrode, the 8D21 was introduced by the *Radio Corporation of America* in 1946, and was the first high-power transmitting tube to be developed for TV broadcast service.

RETMA ELECTIONS HELD

Max F. Balcom, who served as president of the Radio-Electronics-Television Manufacturers Association for two years (1947-49), was elected chairman of the Association's Board of Directors at RETMA's recent 30th anniversary convention in Chicago.

Officers re-elected by the Board of Directors included: Glen McDaniel, president and general counsel; Leslie F. Muter, treasurer; James D. Secret,

executive vice president and secretary; W. R. G. Baker, engineering department director; and John W. Van Allen, general counsel emeritus.

REMOTE CONTROL

In an address before the Florida Association of Broadcasters, Mr. A. Prose Walker, manager of engineering for the National Association of Radio and Television Broadcasters, outlined the fundamental facts of remote control of radio transmitters, and emphasized the fact that the NARTB will petition the Federal Communications Commission to extend remote control to high power and directional stations after sufficient data has been obtained.

Mr. Walker reviewed the economic merits of remote control and cited several examples from stations which have it in operation. He also discussed the reliability of remote control equipment, which case histories show to be equal to if not better than that of equipment used in the more conventional methods of operation.

"STACKED TUBE"

A high-performance "stacked tube" has been developed by *Sylvania Electric Products Inc.* which is capable of unprecedented mass production should a national emergency arise. Less than half the height of a conventional vacuum tube, parts of this tube are stacked one on top of another in the assembly process and riveted together in a single operation on the mounting jig shown in the photograph.

The stacked tube is expected to open up a broad area of new applications be-



cause of its high degree of stability under extreme temperatures, vibration conditions and shock; a recent demonstration for representatives of the Armed Services and industry showed that it will continue to function normally even when subjected to laboratory furnace heat of more than 1000° F. Limited quantities are now be-

WORLD'S FINEST PHONO CARTRIDGES!



Finest cartridges available at any price! True electrodynamic design provides resonance-free performance over entire audio range—20 to 20,000 cycles at intermodulation distortion levels less than 1%.

CARTRIDGE PERFORMANCE DATA

Weight	10 grams
Impedance	1.5 ohms
Equivalent mass at Stylus	.003 grams
Compliance cm/dyne	4.43 x 10 ⁸
Stylus force	5 to 15 grams
*Minimum Output	1 mv
Frequency Response	20 to 20,000 CPS

*1000 cycles RCA test record 12-5-31V

Model ESL 101 (.003" Sapphire)	\$14.95 Net
Model ESL 111 (.001" Microgroove)	\$14.95 Net
Model ESL 121 (.001" Diamond)	\$29.95 Net
Model ESL 131 (.003" Diamond)	\$29.95 Net

High quality, heavily shielded matching transformers with frequency response within 2 db between 20 and 20,000 CPS for use with above ESL cartridges are available.

Send for brochure covering our complete line of record reproducing equipment.

ELECTRO-SONIC LABORATORIES, INC.

35-54 36th Street, Long Island City, New York

SPLICES MAGNETIC TAPE

Neatly - Quickly - Easily

Kit includes plastic splicer which adheres to recorder or worktable, generous supply of pre-cut tape splicing tabs, handy blade, instructions and plastic case. Only \$1.50 postpaid. If your dealer can't supply you, order from ...

COUSINO, INC.

2321 Madison Ave. Toledo 2, Ohio

Professional Directory

GEORGE P. ADAIR Engineering Co.

Consulting Engineers

Radio, Television, Communications,
Electronics

1610 Eye St., N.W. EXecutive 3-1230
Washington 6, D. C.

Paul W. Klipsch
Professional Engineer
Acoustic development
and consulting

Klipsch and Associates
building the authentic
KLIPSCHORN
world's finest sound reproducer

Hope, Arkansas Tel. Hope PRospect 7-395

FRANK H. McINTOSH

Consulting Radio Engineer

1216 Wyatt Bldg., Washington 5, D. C.
MEtropolitan 8-4477
Member AFCEE

MEASUREMENTS CORPORATION



Research &
Manufacturing
Engineers

Harry W. Hauck John M. Van Beuren M. A. Connell
Specialists in the Design and
Development of Electronic Test Instruments
BOONTON, N. J.

GABRIEL ELECTRONICS DIVISION

Formerly Workshop Assoc. Div.
THE GABRIEL COMPANY



Specialists in
High-Frequency
Antennas

Endicott St. Norwood, Mass.
NORWOOD 7-3300

We will be at

WESCON

August 25, 26 and 27

Drop in for a visit!

BOOTH 343.

ing made at the company's Product Development Laboratories at Kew Gardens, L. I., for military use.

ELECTRONIC SUPPLY OFFICE

Keeping pace with the mushroom growth of the electronics industry is the growth of the U. S. Navy's Electronic Supply Office. In the seven years since its initial establishment at Bayonne, N. J., the ESO has outgrown numerous temporary quarters in various locations. Construction on a building designed specifically around its operations began in September, 1952, in Great Lakes, Ill., and the move was finally completed this spring.

The ESO is responsible for inventory control and purchase of all parts needed to keep all Navy electronic equipment in operation. It catalogs and controls more than two hundred thousand different items with an inventory value in excess of three hundred million dollars, and purchases an average of twenty million dollars' worth of parts annually. Although no parts are carried on hand, a detailed reporting system assures that they are available when needed.

Global Communications

(Continued from page 22)

available space, but one exhibit was the subject of two technical papers and deserves brief mention. This was the Polyplex transmission system displayed by the American Cable and Radio Corporation, 67 Broad Street, New York 4, N. Y. The system represents a successful attempt to increase the number of telegraph channels without increasing the bandwidth of the radio carrier.

Polyplex is a composite of single-sideband and frequency-shift techniques. Bandwidth of the present system, which is in effect a double Twinplex transmission from a single radio transmitter, is about 3.85 kc. for four nonsynchronous channels. Each of these four channels is wide enough to carry four channels of an especially developed time-division multiplex which, by synchronizing the keying between the two channels of a Twinplex group, allows for eight 60-wpm printer channels from a single Twinplex group and sixteen such channels from a Polyplex transmission. Individual channel bandwidth in this system, including all guard and keying sidebands, is about 210 cycles on a single Twinplex transmission and about 240 cycles on the two Twinplex groups of a Polyplex transmission. Further improvements indicate that an individual bandwidth of perhaps 100 cycles per channel, including keying sidebands, may be attained.

HICKOK

LABORATORY SIZE VACUUM TUBE Volt Ohm Milliammeter



MODEL 209A

- ★ Large 9" Meter Scale
- ★ Zero-Center DC Scale
- ★ Polarity Reversing Switch

RANGES

Volts, AC-DC and mills DC: 0-1200 in 6 ranges.

Volts, AC, Peak-to-Peak: 0-300 in 5 ranges.

Resistance: 0.1 ohm to 10,000 meg. in 8 ranges.

Capacity: 1 mmf to 1000 mf in 7 ranges.
Current, DC: 5 microamps to 1200 milliamps.

Input Impedance: AC, 3 meg. on 1200 VAC scale. 1200 meg. (shunted by 6 mmf). DC, 12 megohms.

Inductance: 50 mh to 100 henries.

Frequency: 30 cps to 300 megacycles.

Decibels: -20 to +25, in 3 ranges.

13 1/4" H. x 16 1/4" W. x 7" D. 18 1/2 lbs. net wgt.

The versatile Model 209A is a laboratory instrument of highest quality, accuracy and dependability. Ideal for the radio-television manufacturer or service engineer. Designed to meet the large number of applications in the electronic or industrial laboratory. Provides the sensitivity and range for quick and accurate measurements of sine or complex waves of TV or industrial devices. Write today for complete information, or see your nearest HICKOK jobber.

THE HICKOK ELECTRICAL INSTRUMENT CO.
10534 Dupont Ave. • Cleveland 8, O.

Reliable Tubes

(Continued from page 11)

on frame grids. As electrode spacings are reduced to obtain higher performance, the small manufacturing tolerances on parts become enormously important. Grid minor tolerances of .001" or .0015" usually found on side-rod types are satisfactory for grid-cathode spacings of .005" to .007". The same tolerances become virtually impossible when electrode spacing is reduced to .001" or .003". At this point, every ten-thousandth of an inch is important, and a departure from conventional construction becomes a necessity. Another difficulty with side-rod grids is the dependence of the minor diameter dimension on forming operations. For a given grid machine setting, the minor dimension will vary from spool to spool depending on the degree of temper in the wire. The minor diameter tolerance of the frame grid is the flatness of the frame itself and is controlled within one or two ten-thousandths of an inch.

Results of spacing tolerance control are clearly shown in Fig. 6. Data for this chart were taken from a conventional tube type. The tubes were tested directly following exhaust, with no selection. Half of the tubes contained side-rod grids, the remainder frame grids. Figure 6 shows that mutual conductance for frame grid tubes varied much less than for side-rod tubes.

Figure 5 shows a T6½ high-alumina ceramic envelope (at left). Stem pins

are brazed as a preassembly, and the stem-to-bulb seal is made during the processing cycle of the tube. The sealing technique is a simple one-step process consistent with high production. Extremely rugged mechanically, the envelope material is in fact difficult to break. The envelope has withstood severe thermal shock tests such as cycling from boiling water at 100°C to liquid nitrogen at about -195°C, a range of nearly 300°C. A second cycling test from room temperature to 450°C in air was repeated more than 100 times without seal failure. Mount processing and sealing takes place at about 950°C, providing a thorough outgassing of parts. As the high temperature processing schedule enables the tube to be operated at extremely high temperatures with good life expectancy, the ambient temperature application of receiving tubes is therefore greatly extended. Life tests have already been conducted satisfactorily at 300°C and at 400°C ambient. The alumina body, being a crystalline material, can operate at these elevated temperatures without the seal failure caused by electrolysis which so severely limits glass.

Test Results

A list of the static characteristics of both the SN-1724D and the ruggedized 6J6 is given in Table 1. This list illustrates the fact that the static characteristics of stacked tubes are similar to the premium performance tubes in use today. Interelectrode capacities are

somewhat higher for the "D" version, but have been reduced with subsequent designs. The contrast in vibration noise data is of special interest, particularly since the level of shock is six times as great as that used to test the 6J6W.

Figure 7A is a comparative life test graph showing change in mutual conductance with time for the SN-1724D as compared to the 5718. After 2000 hours, the 5718 slumped 13% from its original value as contrasted to the 5% drop of the SN-1724D. In an ambient temperature of 175°C, the SN-1724Dg ("g" denotes glass envelope) dropped about 15% in 1200 hours and thereafter dropped sharply down to about the same level as the 5718. The sudden decrease is attributable to electrolysis in the glass envelope.

Another life test graph of the SN-1724D is shown in Fig. 7B. Stacked tubes mounted in ceramic (SN-1724Dc) were tested at room temperature and at 300°C ambient, with approximately the same slump in each case. The fact that the results of both life tests are similar points to the thoroughness of outgassing that is made possible by deleting mica and glass. (Life test results at 175°C for a SN-1724D sealed in glass were plotted to indicate the limitation imposed by electrolysis failure in glass.) Tests are now being made on stacked tubes in ceramic envelopes in an ambient temperature of 400°C, and after 1000 hours the results indicate that the upper limit of ambient operation has not been reached.

A room temperature test at abnormally high plate dissipation levels is now under way. Tubes were placed on life test with 4-watts dissipation in the plate, raising plate temperature close to cathode temperature. This is an uncommonly severe test for receiving tubes, but after 1000 hours no change in grid current could be read, indicating satisfactory performance. Long-time operation under such conditions is virtually impossible for mica-spaced tubes without decomposition of the mica and subsequent deterioration of performance.

Since the stacked mount design is free of most members susceptible to fatigue, the SN-1724D has high fatigue resistance. Fatigue tests conducted at

TV-AM-FM SET PRODUCTION

Information based on latest reports from RETMA.

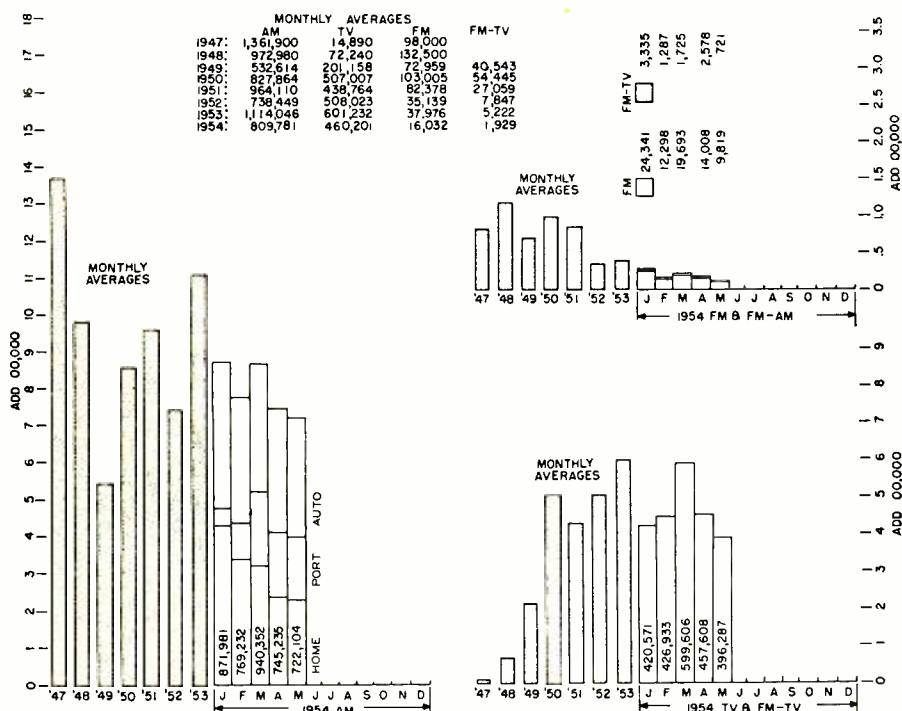

Table 1. Basic characteristics of the SN-1724D as compared with the ruggedized 6J6. Note the superiority of the SN-1724D with respect to vibration noise.

	SN-1724D	6J6W
I_b	8.0 ma.	8.5 ma.
S_m	5000 μ mhos	5300 μ mhos
Mu	30	38
C_{gp}	2.3 μ fd.	1.5 μ fd.
C_{in}	2.3 μ fd.	2.0 μ fd.
C_{out}	.9 μ fd.	.4 μ fd.
Vib.	1-10 mv. at	75 mv. max. at
Noise	15g. 40 cps	2.5g. 25 cps

10g and 60 cps for 96 hours had a negligible effect on static characteristics. Shock tests were also conducted at 500g and 750g. When the tubes were tested subsequently, no increase in noise output could be measured, indicating that the parts were not loosened in shock.

Results of various tests performed on the SN-1724D indicate that stacked designs are more rugged, highly stable under adverse conditions, and more uniform than the conventional prototypes. The data support the conclusions that stacked tubes can be automatically produced and that they will provide much greater receiving tube reliability.

New Products

(Continued from page 25)

sorting or shearing equipment, and motors, the Series 5440 dual preset counter provides output information at any two counts within the maximum capacity of the unit. Various transducers such as photocells, magnetic pickups, switches, etc., may be used to

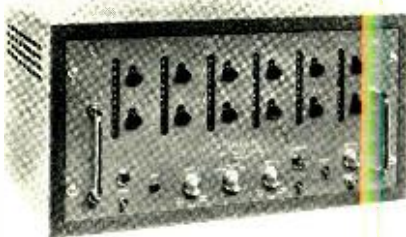

operate the counter, which is being manufactured by Berkeley Division, Beckman Instruments, Inc., 2200 Wright Ave., Richmond, Calif.

Any discrete physical change represented by a changing voltage can be counted; the physical change may occur at rates between d.c. and 40,000 times per second. Presetting the counter is accomplished by rotating the two switches adjacent to each decade.

VACUUM-TUBE VOLTMETER

All frequencies from 10 cps to 4 mc. are covered by the vacuum-tube voltmeter now being manufactured by Hewlett-Packard Company. Model 400D measures voltages from 0.1 mv. to 300 v., and is accurate to within 2% up to 1 mc. A new amplifier circuit provides approximately 56 db of feedback in midrange for high stability and freedom from calibration changes caused by external conditions. Direct readings are available without calculation or conversion between -72 dbm and +52 dbm.

In addition to measuring gain, response and output level, Model 400D also measures hum and noise directly, determines power circuit and broad-

cast high frequency voltages, serves as an audio level meter and high gain broadband amplifier, detects nulls, monitors waveforms and measures coil Q, capacity and resonance. For complete details, write Hewlett-Packard Company, Dept. P, 395 Page Mill Rd., Palo Alto, Calif.

MAGNETIC AMPLIFIERS

Four sizes of magnetic amplifiers for servo motor applications have been made available by the United Transformer Company, 150 Varick St., New York 3, N. Y. When used with a 115-volt, 400-cycle supply, Types MAT-1, -2, -3, and -4 will respectively handle 2-, 4-, 6- or 9-watt servo motors; when used with a 230-volt, 400-cycle supply, the ratings for all types are doubled.

These units are extremely compact, hermetically sealed, and magnetically shielded. The output is sinusoidal, amplitude variable, and phase reversible. Control is provided by a dual triode such as a 12AU7 operating at 400 cycles or higher, and response time is approximately 7.5 milliseconds.

NETWORK BOARD

Facilities for the rapid connection and evaluation of developmental RC circuits are provided on a single panel by the Model P100 network board, available from Instrument Research Company, 371 Harvard St., Cambridge 38, Mass. The instrument incorporates three 4-dial resistance decade units—each covering the range of 0 to 1,111,000 ohms in 100-ohm steps, and three 4-dial capacitance decade units—each covering the range of 0 to 1.111 μ fd. in 0.001- μ fd. steps.

Designed for convenience and the conservation of engineering time, Model P100 is expected to find wide application in the development and testing of attenuators, feedback networks, equalizers, voltage dividers, and phase shifters. It has a unique switching

circuit which graphically portrays the possible circuit combinations to the operator.

PULSE TRANSFORMER

Type PT-4 "Labtrans" hermetically sealed pulse transformer, announced by Berkshire Laboratories, 504 Beaver



Pond Rd., Lincoln, Mass., is a versatile four-winding unit with 2:2:1:1 turns ratios. Measured characteristics include 120-ohm characteristic impedance, .03- μ sec. rise time, 20% droop at 1 μ sec., and 40% droop at 2 μ sec.

As a pulse or trigger generator, Type PT-4 may be used in many different blocking oscillator circuits; it may also be used for coupling, impedance matching, etc. The core is of the wound type, using high-quality uncut magnetic material, and the windings are brought out to eight terminals provided with solder lugs.

ZOPHAR

WAXES

COMPOUNDS

Zophar waxes, resins and compounds to impregnate, dip, seal, embed, or pot, electronic and electrical equipment or components of all types; radio, television, etc.

Cold flows from 100°F. to 285°F.

Special waxes non-cracking at -76°F.

Compounds meeting Government specifications, plain or fungus resistant.

Let us help you with your engineering problems.



ZOPHAR MILLS, INC.
112-130 26th Street,
Brooklyn 32, N. Y.

Color Encoding

(Continued from page 14)

bridging the output with a shorted line to produce the gating pulse. After amplification, this pulse is applied to the burst generator.

Mixing of chrominance, luminance, composite sync and the color synchronizing burst to form the composite signal is accomplished in a dual pentode stage having a common plate load in tandem with a second pentode. (See Fig. 8B) Chrominance and luminance information are fed respectively to the signal grids of the dual stage, and composite sync is d.c.-coupled into the cathode of the tube receiving the luminance information. The resulting signal is fed to the tandem stage, where the color synchronizing burst is added by means of cathode injection. This arrangement provides a maximum of isolation between the components being mixed and eliminates interdependence of level-setting controls.

The resulting composite signal is fed to the dual output stages through a cathode follower for maximum bandwidth considerations. Two type 5687 tubes in parallel comprise each output stage and are used as a.c.-coupled plate-loaded amplifiers; 75 Ω terminations at the chassis connector in conjunction with the termination at the cable end cause the net load to be 37 Ω . Parallel type 5687 tubes provide a signal with a high degree of linearity.

Certain novel features which bear mention are included in the *Du Mont* Type 9016 color encoder. A Type 9011 "Handy-Dandy" filter is provided on the chassis with input and output test points. This filter is a high-pass—low-pass direct switchable type for the purpose of examining with an oscillograph the chrominance, luminance or combined information in the composite color signal. In operation, a test lead from either of the dual outputs is plugged into the filter input and an oscillograph lead is plugged into the

filter output. The filter switch then selects which part of the information in the color signal is to be presented in the oscillograph.

The method of handling subcarrier after it has entered the unit makes it possible to utilize this encoder in a multienncoder installation in which sync and burst are added at master control. In such an installation, care has to be taken to phase the subcarrier fed to the modulators properly by adjusting the transmission line lengths. As an aid to adjusting cable lengths, the subcarrier enters the encoder by means of a lumped-constant delay line with eight switchable positions, each position representing a 45° delay of the subcarrier. Thus, for equalizing the phase in a multienncoder installation, a maximum correction of only 45° has to be provided by transmission line length.

Checking Performance

While the encoder is as complicated a piece of equipment as now exists in a color television system, checking its performance is relatively simple. Necessary equipment includes a color bar generator, a highly linear wide-band oscillograph, and a vectorscope; the wide-band oscillograph may also be the indicating device for the vectorscope. The following steps provide rapid checking of performance (Fig. 9):

1. Oscillograph presentation of the composite signal should be checked for conformation with the idealized waveform shown in (A). In addition to proper amplitude and time position relationships, blanking level and sync tip should be clean and free of subcarrier and spurious signals.
2. Inasmuch as the normal oscillograph presentation shows only the resultant of angular and amplitude errors in the chrominance components (Q and I), a vectorscope presentation is necessary or at least advisable. With the decoded I signal on the Y axis and the decoded

Q signal on the X axis of an oscillograph having identical X and Y responses, the color bar signal should result in a display as shown in (B). The color bars should fall within the squares shown, which indicate tolerances of $\pm 10^\circ$ and $\pm 20\%$ in amplitude as specified by the FCC.

The output of the encoder should comply with the idealized displays just described over a prolonged period of time. Equipment with insufficient short- and long-term stability, which requires frequent adjustment, results in poor signal quality and excessive demands on the time of valuable station personnel.

Conclusion

This article has been presented with a view toward clearing up some of the mystery which has surrounded the encoding function in the relatively new field of color television. It is hoped that the readers now have at least a small insight into the principles of color encoding as well as a yardstick for judging encoder performance.

The authors wish to take this opportunity to acknowledge the contributions of their colleague, Mr. Michael Kelly, who gave valuable aid in devising the delay line—filter combinations described.

Visual Demodulator

(Continued from page 20)

equipment. Figures 7 and 8 show respectively over-all transient response of the demodulator to a perfect DSB transmitter without and with the phase corrective network in the output of the demodulator.

A switch is provided to connect the output of a crystal demodulator signal to the video amplifier input. The sound traps are removed in this position and permit measurement of the rectified signal without an i.f. characteristic. The equipment is used in this way to make amplitude-vs.-frequency measurements.

In order to obtain a zero reference marker (refer to Fig. 9), the local oscillator is temporarily interrupted by a negative keyer pulse. The pulse is coupled to the first multiplier grid of the local oscillator, and the local oscillator output is reduced to zero for the duration of the pulse. A positive keyer pulse is introduced into the picture video amplifier to "fill in" the hole caused by keying off the local oscillator. The hole is filled in so as not to disturb the operation of the synchronizing and blanking circuits of the associated monitoring equipment.

The keyer signal is generated by pulse-forming circuits which form a

Fig. 9. Idealized encoder presentations: (A) composite output, (B) vectorscope display.

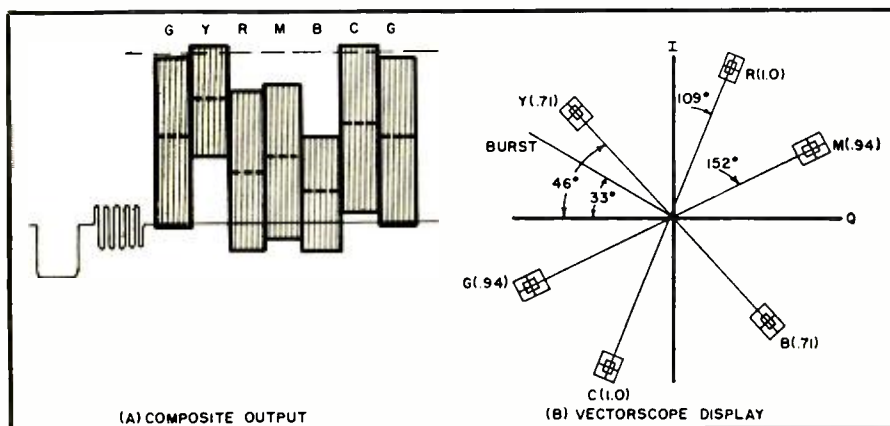

trigger pulse from the video output signal; this pulse triggers multivibrator V_2 , which produces a keyer signal during the vertical blanking interval at a 60-cps rate.

Conclusion

As in any work of this sort, many individuals have contributed toward the end product. Much of the work was performed under the direction of Henry Samuelson of the Electronics Laboratory of the *General Electric Company*. J. W. Downe contributed greatly to the development of the v.h.f. unit in his capacity as project engineer.

New Literature

(Continued from page 30)

of various practical duplexer designs, enabling the microwave engineer or equipment manufacturer to evaluate the type best suited for his particular transmitter-receiver application.

Two basic types of *Airtron* duplexers are also described in Technical Bulletin T-2200, which may be obtained free of charge by writing directly to *Airtron, Inc.*, Dept. A, 1103 W. Elizabeth Ave., Linden, N. J.

SCHOOL LABORATORY EQUIPMENT

TIC Laboratory Report No. 9 features applications of the Type 310-A Z-angle meter and the Type 320-AB phase meter in school laboratories. Enclosures with this report cover several representative experiments conducted at various colleges which suggest methods for use of certain instruments to simplify common electrical measurements for students.

Copies of Laboratory Report No. 9, together with the enclosures, may be obtained by writing to *Technology Instrument Corporation*, 531 Main St., Acton, Mass.

MICAMOLD PRODUCTS

Two engineering bulletins are available on request from *Micamold Radio Corporation*, 1087 Flushing Ave., Brooklyn 37, N. Y. Bulletin #107 is a four-page brochure illustrating 11 types of r.f. interference filters and noise suppression capacitors; it contains photographs and dimension drawings, plus a table of specifications showing type number, power ratings and r.f. attenu-

PHOTO CREDITS

PAGE	CREDIT
7, 8, 9	RCA Communications, Inc.
11	Sylvania Elec. Products, Inc.
12	Allen B. Du Mont Labs.
15, 16	Chemalloy-Electronics Inc.
17	General Electric Co.

INDEX OF ADVERTISERS

NAME	PAGE	NAME	PAGE
Admir Engineering Co., George P.	35	Gabriel Company, The	35
Ampex Corp.	19	Harvey Radio Co., Inc.	32
Automatic Switch Co.	23	Hickock Electric Instrument Co., The	35
Berndt-Bach, Inc.	31	Klipsch & Associates	35
Burnell & Co., Inc.	31	McIntosh, Frank H.	35
Camera Equipment Co.	27	Measurements Corporation	35
Carter Motor Co.	29	Monitoradio Radio Apparatus Corp.	27
Chicago Standard Transformer Corp.	4	Precision Paper Tube Co.	29
Connecticut Telephone & Electric Corp.	6	Premier Metal Products Company	39
Cosimo, Inc.	34	Pye Limited	5
Electro-Sonic Laboratories, Inc.	34	Radio Corporation of America	3, 21
Electro-Voice	33	United Transformer Co.	Second Cover
Freed Transformer Co., Inc.	Fourth Cover	Zophar Mills, Inc.	37

ation characteristics. Bulletin #108 is a one-page data sheet dealing with pulse-forming networks and delay lines; the operating principle and construction details of these units are discussed and common applications suggested.

ALLIED FACILITIES

An eight-page catalog just published by *Allied International, Inc.*, presents the design, development, production and assembly work done by its *Allied Engineering Division* for the electronics industry. Product photographs and the descriptive text point up *Allied's* ability to miniaturize entire assemblies, redesign products to meet specifications, or manufacture to precise tolerances.

Inquiries should be addressed to Mr.

A. L. Patterson, President, *Allied International, Inc.*, *Allied Engineering Division*, 230 Park Ave., New York 17, N. Y. Individual copies of the catalog will be supplied free of charge.

QUARTZ CRYSTALS

"Quartz Crystals" is the title of a six-page illustrated brochure which contains all the pertinent information needed in ordering *G-E* custom-made crystals. Five crystal holder types are graphically shown, and seven district offices from which crystal advisory service may be obtained are listed.

Copies of the brochure are free on request from the *General Electric Company*, Germanium Products, Electronics Park, Syracuse, N. Y.

It's easy to multiply with
PREMIER
New Heavy-Duty Cabinet Racks
FOR MULTIPLE INSTALLATIONS

FOR STANDARD 19" WIDE PANELS

SEND FOR CATALOG

PR Series

- Each unit consists of 1 frame and 2 doors.
- 3 panel space heights available — 61 1/4", 70" and 77".
- Doors hinged for either left or right hand opening.
- Sides are detachable for multiple assembly.
- 3/16" adjustable panel mounting angles.
- Finished in either Black or Gray wrinkle, Gray or Brown Hammertone.

PREMIER METAL PRODUCTS COMPANY
PRECISION BUILT METAL HOUSINGS
3160 WEBSTER AVENUE • BRONX 67, NEW YORK



HERMETICALLY SEALED COMPONENTS



COMMERCIAL COMPONENTS



HI-FIDELITY TRANSFORMERS



FREEDSEAL TREATMENT



MINIATURE TRANSISTOR TRANSFORMERS



PULSE TRANSFORMERS



MINIATURE AUDIO TRANSFORMERS



LOW-FREQUENCY HI-Q REACTORS



TOROIDAL INDUCTORS



SUB-MINIATURE TOROIDS



HI-TEMPERATURE COMPONENTS



SLUG TUNED COMPONENTS



CHARGING REACTORS

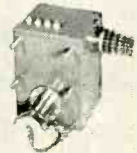

HI-LEVEL PULSE TRANSFORMERS



SUB-MINIATURE HERMETICALLY SEALED COMPONENTS

Your Condensed Directory of **FREED** Quality Products



FILTER REACTORS



STEP-DOWN TRANSFORMERS



POWER TRANSFORMERS



CHANNEL MOUNTING



PRECISION FILTERS



HIGH-Q REACTORS



SATURABLE CORE REACTORS



MAGNETIC AMPLIFIERS



1900 MAGNETIC A.C. VOLTAGE REGULATOR



1020-B MEGOHMMETER



1010-A COMPARISON AND LIMITED BRIDGE



1110-A INCREMENTAL INDUCTANCE BRIDGE



1150 UNIVERSAL BRIDGE



1210-A NULL DETECTOR AND VACUUM TUBE VOLTMETER



1140-A NULL DETECTOR-AMPLIFIER



1030-A LOW FREQUENCY "Q" INDICATOR

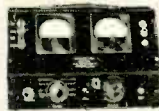

1620 MEGOHMMETER



1870 INCREMENTAL INDUCTANCE COMPARISON BRIDGE



1040 A.C.-V.T. VOLTMETER



1060 VACUUM TUBE VOLTMETER



1560 DIFFERENTIAL VOLTMETER



1580 DB DECADE AMPLIFIER



1570 COMPARISON BRIDGE



1170 D.C. SUPPLY

While this page shows a representative group of Freed Products, it only indicates the vast facilities we have for engineering and advanced development. Our five plants are integrated in one area and are well coordinated from basic research to finished product. Solving difficult engineering problems is a challenge we are always ready to accept. Inquiries will be handled promptly.



DECADE CAPACITORS



DECADE INDUCTORS



DISTORTION METER

SEND FOR COMPLETE TRANSFORMER AND INSTRUMENT CATALOGS



FREED TRANSFORMER CO., INC.

1722 WEIRFIELD ST., BROOKLYN (Ridgewood) 27, N. Y.



1950 NULL FILTERS